

# CENTER<sup>®</sup> 376

Data Logger  
RTD THERMOMETER



*Instruction Manual*  
SE-376



**Data Logger**  
**RTD THERMOMETER**  
**CE**

# CONTENTS

---

TITLE	PAGE
<b>1. Introduction</b> .....	1
<b>2. Specifications</b> .....	1
<b>3. Symbol Definition and Button Location</b> .....	2
<b>4. Operation Instructions</b> .....	3
4.1 Power-Up.....	3
4.2 Connection the Temperature Probe.....	3
4.3 Selecting the Temperature Scale.....	3
4.4 Data-Hold Operation.....	3
4.5 Back light Operation.....	3
4.6 Relative Operation.....	3
4.7 Record Operation.....	3
4.8 MAX/MIN Operation.....	3
4.9 Auto Power Off.....	4
4.10 Low Battery Condition.....	4
<b>5. Temperature Measurement</b> .....	4
<b>6. Setting the Time</b> .....	5
<b>7. Changing the Logging Interval</b> .....	5
<b>8. Clearing Memory</b> .....	5
<b>9. Temperature Meter Calibration Setup</b> .....	6
<b>10. Communicating with a PC</b> .....	7
Testlink SE-376 Software.....	7
<b>11. Power Preparation</b> .....	12
<b>12. Maintenance</b> .....	12
<b>13. Temperature Probe</b> .....	12

## 1. INSTRUCTION

This instrument is a digital thermometer for use with platinum-type temperature sensor. Temperature indication follows IEC751 temperature table for PT-type sensor.

## 2. SPECIFICATIONS

**Numerical Display:** 5 digital liquid crystal displays

**Measurement Range:** -100°C ~ 400°C; -148°F ~ 752°F

**Resolution:** 0.01°C; 0.02°F;

**Sensor types:**

Platinum resistance temperature sensor for pt-100 4 wires.

ALPHA=0.00385

**Environmental:**

- Operating Temperature and Humidity:  
0°C ~50°C (32°F ~ 122°F) ; 0 ~ 80% RH
- Storage Temperature:  
-10°C to 60°C (14°F ~ 140°F); 0 ~ 80% RH
- Altitude up to 2000 meters.

**Accuracy:** at ( 23 ± 5°C )

Range	Accuracy
-100°C ~ 400°C	±(0.05% reading + 0.1°C)
-148°F ~ 752°F	±(0.05% reading + 0.2°F)

**Temperature Coefficient:**

For ambient temperatures from 0°C ~ 18°C and 28°C ~ 50°C, for each °C ambient below 18°C or above 28°C add the following tolerance into the accuracy spec.

0.005% of reading + 0.01°C ( 0.005% of reading + 0.02°F )

**Note:**

*The basic accuracy Specification does not include the error of the probe please refer to the probe accuracy specification for additional details.*

**Sample Rate:** 2 times per second

**Dimension:** 185 x 65 x 36 mm(meter only)

**Weight:** 360g Approx.

**Power requirement:**

9V Battery;

AC adapter: 9V DC(7~10V Max.)/20mA Min (Plug Diameter: 3.5mmx1.35mm)

**Battery Life:** Approx. 100hours

**Standard Accessory:**

Pt-100 Probe(class A), Instruction manual, 9V Battery, windows software, carrying case, USB cable.

**Optional Accessories:** AC adapter, RS-232 Cable.

**3. SYMBOL DEFINITION & BUTTON LOCATION**

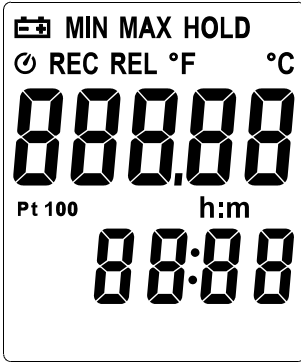

- : The Battery is not sufficient for proper operation.

---

- MIN** : The Minimum value is now being displayed

---

- MAX** : The Maximum value is now being displayed

---

- HOLD** : This indicates that the display data is being hold.

---

- : This indicates Auto Power Off is enabled.

---

- REC** : Readings are being logged.

---

- REL** : The reading is now under Relative Mode.

---

- °C °F** : Centigrade and Fahrenheit indication.

---

- : This indicates that the minus temperature is sensed.

---

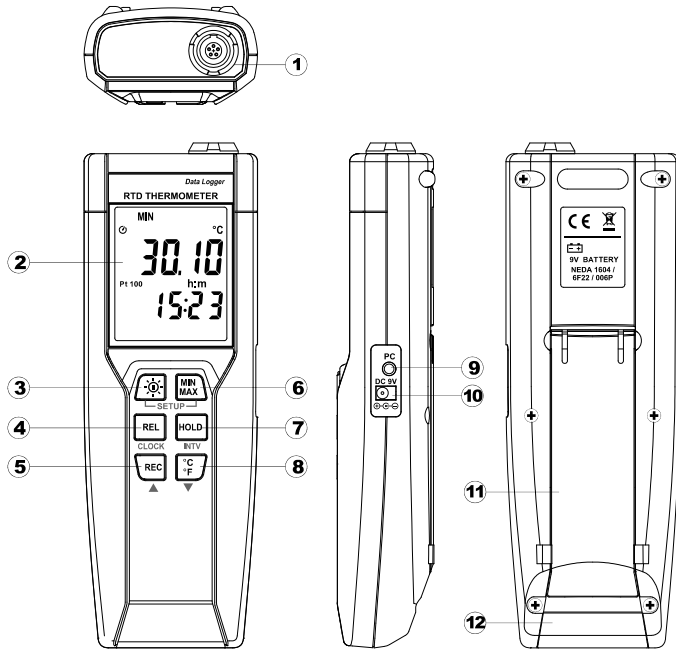

- h:m** : hours; minute



- |  |                                    |
|--|------------------------------------|
| ① Pt type temperature sensor connector | ⑦ HOLD button                      |
| ② LCD display                          | ⑧ °C , °F control button           |
| ③ Power ON/OFF and Back light button   | ⑨ PC Interface                     |
| ④ Relative readout button              | ⑩ External DC 9V power supply jack |
| ⑤ REC button                           | ⑪ Tilt stand                       |
| ⑥ MAX MIN control button               | ⑫ Battery Compartment              |

## 4. OPERATION INSTRUCTIONS

### 4.1 Power-Up

Press the “” key to turn **ON** the thermometer and Press and hold “” buttons for 3 seconds to **OFF**.

### 4.2 Connection the Temperature Probe

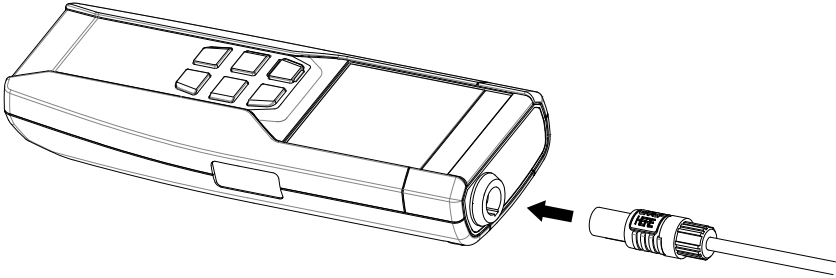

For measurement, plug the temperature probe into the input connectors.





### 4.3 Selecting the Temperature Scale

When the meter was first power on, the default scale setting is set at Celsius (°C) scale. The user may change it to Fahrenheit (°F) by pressing  button and vice versa to Celsius and change default scale.

### 4.4 Data-Hold Operation

The user may hold the present reading and keep it on the display by pressing the  button. When the hold data is no longer needed, one may release the data-hold operation by pressing  button again.



When the meter is under Data Hold operation, the ,  and  button are disabled.

### 4.5 Back light Operation:

Press the  button will turn back light on and Press it once again will turn off.

The meter will turn back light off if there is no push  button for 30 seconds.

### 4.6 Relative Operation:

When one press the  button, the meter will memorize the present reading and the difference between the new reading and the memorized data will be shown on the display. Press the  button again to exit the Relative operation.

### 4.7 Record Operation:

Starting and Stopping Logging Setup, memory clear, and PC communications are inaccessible during logging.

Set the logging interval. (See “Changing the Logging Interval.”)







Press  button to start logging. The display shows “REC”.

Press  button again to stop logging.

### 4.8 MAX/MIN Operation:

When one press the  button the meter will enter the MAXMIN mode. Under this mode the maximum value, minimum value is kept in the memory simultaneously and updated with every new data.

When the **MAX** symbol is display, the Maximum is shown on the display.

Press  button again, then the **MIN** symbol is on the display and also the minimum reading.  
 Press  button again, **MAX** and **MIN** will blink together. This means that all these data is updated in the memory and the reading is the present temperature.  
 One may press  to circulate the display mode among these options.  
 When the meter is under MAXMIN operation,  and  button are disabled.  
 To exit the MAX/MIN mode, one may press and hold  button for two seconds.

**4.9 Auto Power Off:**

By default, when the meter is powered on, it is under auto power off mode. The meter will power itself off after 30 minutes if no key operation.  
 One may press and hold  button and then power on the meter and there will be two successive beeps to indicate that auto power off is disabled.

**4.10 Low Battery Condition:**

The temperature meter low battery indication as follows:

	Low battery. Replace the batteries.
---	-------------------------------------

**5. TEMPERATURE MEASUREMENT**

**5.1 Correct Measurement Method:**

The temperature sensor is located at the end of the metal sheath of the sheath type TEMPERATURE PROBE. To accurately test internal temperature insert the probe into the item you want to measure to a distance at least 15 times the diameter of the sheath.

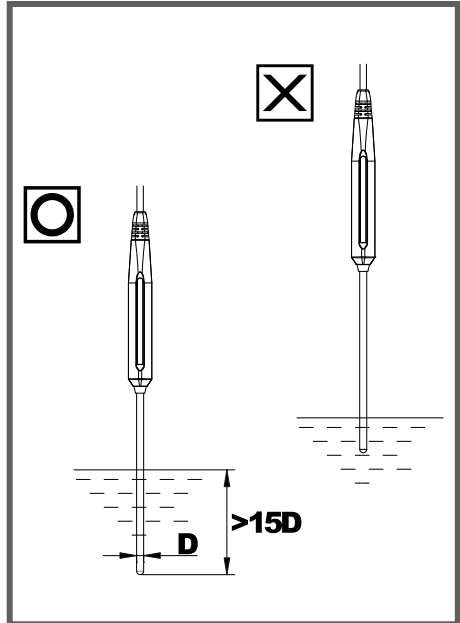

**5.2 Connector Configuration:**

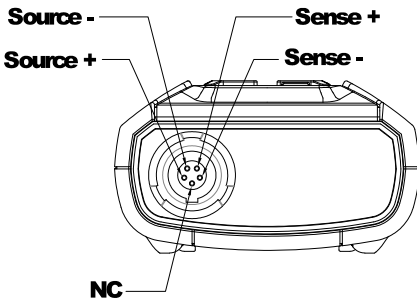



## 6. SETTING THE TIME

- 6.1 Press and hold  $\left[ \begin{smallmatrix} \text{MIN} \\ \text{MAX} \end{smallmatrix} \right]$  button and then power on the meter to enter setup mode.
- 6.2 Press  $\left[ \text{REL} \right]$  button to enter Time setting mode. The right two digits blink.
- 6.3 Press  $\left[ \text{REC} \right]$ ▲ or  $\left[ \begin{smallmatrix} \text{°C} \\ \text{°F} \end{smallmatrix} \right]$ ▼ button until the display shows the correct **year**, and then press  $\left[ \text{REL} \right]$  button to select. The left two digits blink.
- 6.4 Press  $\left[ \text{REC} \right]$ ▲ or  $\left[ \begin{smallmatrix} \text{°C} \\ \text{°F} \end{smallmatrix} \right]$ ▼ button until the display shows the correct **month**, and then press  $\left[ \text{REL} \right]$  button to select. The right two digits blink.
- 6.5 Press  $\left[ \text{REC} \right]$ ▲ or  $\left[ \begin{smallmatrix} \text{°C} \\ \text{°F} \end{smallmatrix} \right]$ ▼ button until the display shows the correct **day**, and then press  $\left[ \text{REL} \right]$  button to select. The left two digits blink.
- 6.6 Press  $\left[ \text{REC} \right]$ ▲ or  $\left[ \begin{smallmatrix} \text{°C} \\ \text{°F} \end{smallmatrix} \right]$ ▼ button until the display shows the correct **hour** (24-hour format), and then press  $\left[ \text{REL} \right]$  button to select. The right two digits blink.
- 6.7 Press  $\left[ \text{REC} \right]$ ▲ or  $\left[ \begin{smallmatrix} \text{°C} \\ \text{°F} \end{smallmatrix} \right]$ ▼ button until the display shows the correct **minutes**, and then press  $\left[ \text{REL} \right]$  button to store the time in memory.

### Note:

*Holding down "REC" or "°C/°F" causes the number to change more quickly.*

## 7. CHANGING THE LOGGING INTERVAL

The logging interval determines how often the thermometer stores logged readings in memory.

- 7.1 Press and hold  $\left[ \begin{smallmatrix} \text{MIN} \\ \text{MAX} \end{smallmatrix} \right]$  button and then power on the meter to enter setup mode.
- 7.2 Press  $\left[ \text{HOLD} \right]$  button to enter Interval setting mode. The left two digits blink.
- 7.3 Press  $\left[ \text{REC} \right]$ ▲ or  $\left[ \begin{smallmatrix} \text{°C} \\ \text{°F} \end{smallmatrix} \right]$ ▼ button until the display shows the correct **hour** (24-hour format), and then press  $\left[ \text{REL} \right]$  button to select. The right two digits blink.
- 7.4 Press  $\left[ \text{REC} \right]$ ▲ or  $\left[ \begin{smallmatrix} \text{°C} \\ \text{°F} \end{smallmatrix} \right]$ ▼ button until the display shows the correct **minutes**, and then press  $\left[ \text{REL} \right]$  button to store the time in memory.

### Note:

*Holding down "REC" or "°C/°F" causes the number to change more quickly.*

## 8. CLEARING MEMORY

When memory is full, **REC** appears and blinks on the display and logging stops.

You can clear memory in next power on the meter to enter clear memory mode.

Press and hold  $\left[ \text{REC} \right]$  button and then power on the meter to enter clear memory mode to delete logged readings from memory. The display shows the number from 5 decreases to 0.

## 9. TEMPERATURE METER CALIBRATION SETUP

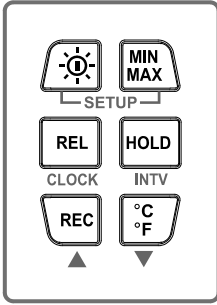

Below table diagram shows each button function when user enter into calibration mode.

**Note:**

Turn the Power "OFF" before attempting following SETUP.  
Setup mode is cancelled during below procedure if "POWER" button is pressed.

### 9.1 Temperature Calibration

Place the temperature probe in a known, stable temperature environment. Allow the readings to stabilize. In Setup change the offset until the display reading matches the calibration temperature.

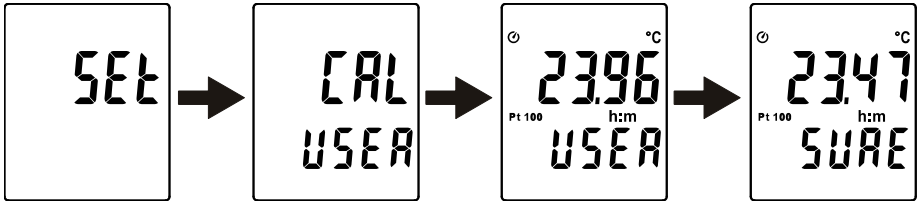

Press and hold **REL** + **HOLD** buttons and then power on the meter to enter setup mode.

Press **°C/°F** button to enter calibration mode.(in 3 seconds)

Press **HOLD** button to enter calibration mode. (in 3 seconds)

Press **REC** or **°C/°F** button to confirm present Temperature value.

Press **HOLD** button twice to confirm selection.

**Note:** To abort during the process, press **⊖** button to exit calibration mode.

### 9.2 Recall Default factory setting value

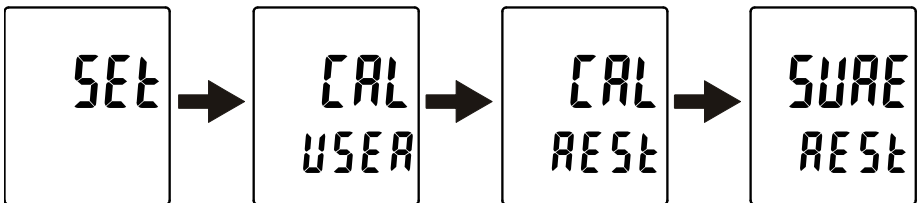

Press and hold **REL** + **HOLD** buttons and then power on the meter to enter setup mode.

Press **°C/°F** button to enter calibration mode. (in 3 seconds)

Press **MIN/MAX** button to enter recall mode. (in 3 seconds)

Press **HOLD** button to confirm revert back to “Default factory setting value”

Press **HOLD** button to confirm selection.

**Note:** To abort during the process, press  button to exit calibration mode.

## 10. COMMUNICATION WITH A PC

Users can transfer data from the built-in memory on the instrument to a PC through SE376 software. The communication requires a USB or RS-232 serial connection.

### TESTLINK SE-376 SOFTWARE

#### (1)The SE-376 package contains:

- 80mm CD
- Custom designed USB cable for SE376

#### (2)System Required:

Windows NT 4.0/ NT2000/ XP/ VISTA/ Windows 7

#### (3)Minimum Hardware Required:

- PC or NoteBook with Pentium 800MHz or higher, 128 MB RAM
- At least 50 MB hard disk space available to install SE376
- Recommended screen resolution 1024X768 or above

#### (4) Install SE-376 and USB-120 connector driver:

1. We recommend close all other application before installing SE376.
2. Insert setup CD disk to CD disk drive to display install screen. You may also run MainSetup.exe in the directory of the CD.
3. Click Install to begin installation.
4. It will install USB-120 connector driver first:
5. While installing, it will show this window below, just click “**next**” to continue.(see Fig.1)
6. Select “**Launch the CP210x VCP Driver Installer**” option, and then click Finish. (see Fig.2)

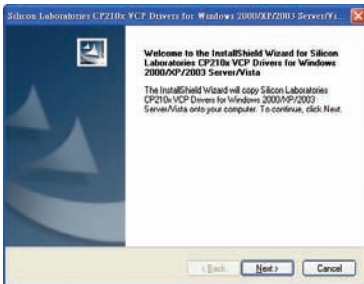

(Fig.1)

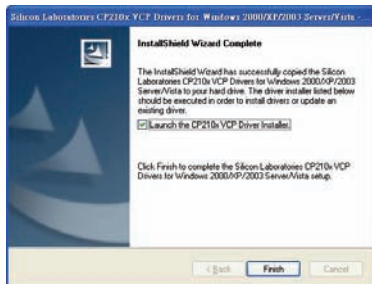

(Fig.2)

7. Click Install.

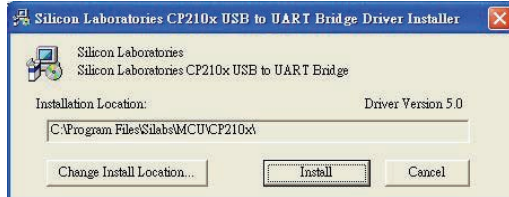

8. After finish installing USB-120 connector driver, it will install SE376 software automatically. it will copy SE376.exe ( executable file ) and help file to your hard disk ( default is c:\program files\SE376.

9. After finish installation, plug USB-120 connector to PC usb port, execute.

10. "start"→ "My Computer", then choose "View System Information" on the left top of the window, the window below will show up.

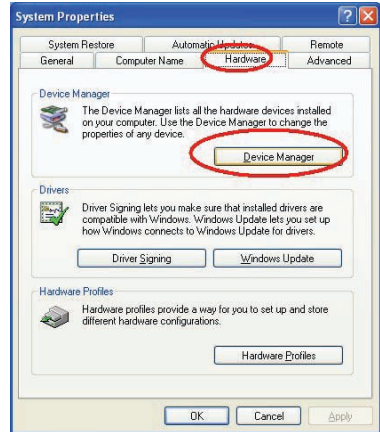



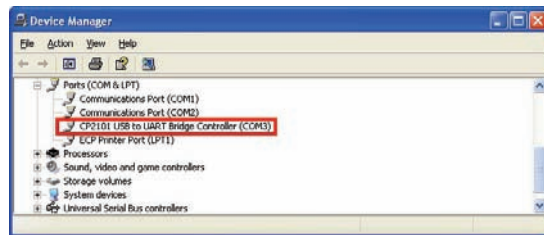

11. Choose "Hardware" option and click "Device Manager" button, click "+" symbol on the left side of Ports(COM &LPT), if the device "CP2101 USB to UART Bridge Controller(COMx)" is in the list, the connector is ready to work.

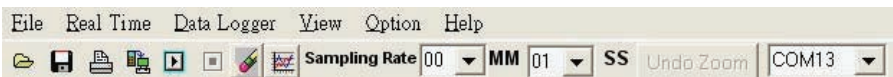

**(5)Main menu and buttons:**



-  **Open** - Retrieve files from the disk
-  **Save** - Save the present data to the disk
-  **Print** - Send data in the present table to the printer
-  **Pause** - Stop data recording



**R**un - Start data recording



**O**utput To Graph - Send tabular data to another graph



**N**ew - Reset all the data

**Option** - Setup dialog to set attributions of graph. (You can also double click on the graph.)

**Sampling Rate** - Time interval between each data to be recorded. If you want to change it, move mouse cursor to the digit you want to change and click, then input the new sampling rate. The change will be effective immediately. It will keep up to 5000 data points, when data points exceed this limit, the oldest 100 points will be replaced sequentially.

## (6)Real Time Graph:

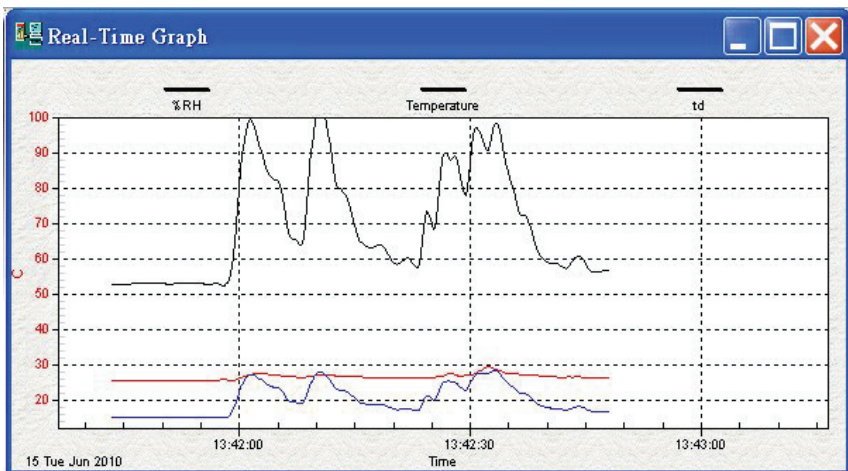

You can Zoom this graph by using mouse:

### To Zoom:

1. Press and hold the Shift key
2. Press the left mouse button and drag the cursor to select the new extents
3. Release the mouse button

### To Undo the Zoom:

Press the Alt+U key or click Undo Zoom button

**Note:** Zooming method is not allowed in Real Time Graph Window.

**(7)Tabular:**

NO	DATE	TIME	RH	T	td	UNIT
58	2010/6/15	13:42:40	58.5	26.6	17.6	C
59	2010/6/15	13:42:41	58.5	26.4	17.4	C
60	2010/6/15	13:42:42	57.2	26.4	17.1	C
61	2010/6/15	13:42:43	59.5	26.4	17.7	C
62	2010/6/15	13:42:44	60.4	26.4	18.0	C
63	2010/6/15	13:42:45	57.0	26.3	17.0	C
64	2010/6/15	13:42:46	56.1	26.2	16.6	C
65	2010/6/15	13:42:47	56.5	26.2	16.7	C
66	2010/6/15	13:42:48	56.4	26.2	16.7	C

The Tabular window can be used to record real time data in a table format. The maximum number of records that the Tabular window can keep will be depending on how many available memory and hard disk space of the connected computer.

**(8)Data Logger**

When you have thermometer connected to computer, select "Load Data" to start loading the recorded data from the thermometer. There will be a progress indicator to show the loading progress.

If error occurs, just click "Load Data" again.

After the data has been successfully loaded to computer, the left side window shows how many data sets were loaded and their detailed information (start date, start time, recording rate, and record numbers).

For example:

Set	DATE	TIME	Rate	Nums
1	2010/5/7	下午 07:42:18	08:33	1
2	2010/5/7	下午 07:55:39	20:59	1
3	2010/6/25	下午 01:37:57	20:59	1
4	2010/6/25	下午 01:38:01	20:59	1
5	2010/6/25	下午 01:38:03	20:59	1
6	2010/6/25	下午 01:38:05	20:59	1
7	2010/6/25	下午 01:38:07	20:59	1
8	2010/6/25	下午 01:38:14	20:59	1
9	2010/6/25	下午 01:38:17	20:59	1
10	2010/6/25	下午 01:38:30	20:59	1
11	2010/6/25	下午 01:38:32	20:59	1

It will transfer the first data set to graph and tabular on the right side window once you finish loading recorded data from the thermometer. You can click on any data set to show its graph and tabular on the right side window.

You can choose a rectangle area on the graph to zoom in for detail.

The vertical dash line in the graph will match the highlight row in the tabular. When clicking on another row in the tabular, the vertical dash line will move to the corresponding position to match the time.

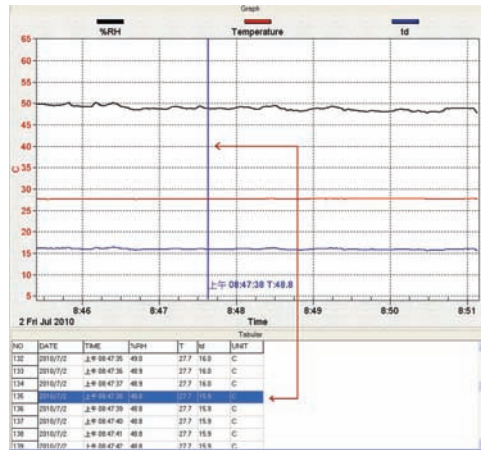

### (9)Frequently Asked Question:

**Q:** I have connected thermometer to computer serial port and turned thermometer on, but it still shows "NO CONNECTION" ?

**A:** It could be caused by that all serial port are occupied by other applications. Close all application, restart your computer, and run SE376 again.

**Q:** In TABULAR window, I saved a file. Can I use EXCEL to open this file?

**A:** If the decimal separator is comma (,) in your area, you cannot use CSV file because CSV file use comma to separate data. This will cause confusion (for example 23,6,C,24.6,C).

However, you can use TXT files instead. It uses tab to separate to data.

(For example: 23.6 C 24.6 C) and it can be accepted in EXCEL.

**Q:** How to uninstall SE376?

**A:** Uninstall SE376 by launching the Add/Remove Programs applet out of the Control Panel, highlighting the SE376, and clicking on the Add/Remove... button, then it will remove the SE376 folder and files from your computer.

## 11. POWER PREPARATION

### 11.1 Battery Loading

Remove the battery cover on the back and insert one 9V battery.

### 11.2 Battery Replacement

When the battery voltage drops below the operating voltage, Low battery indicator  will appear. Replace a 9 Volt battery immediately to ensure the unit functions properly.

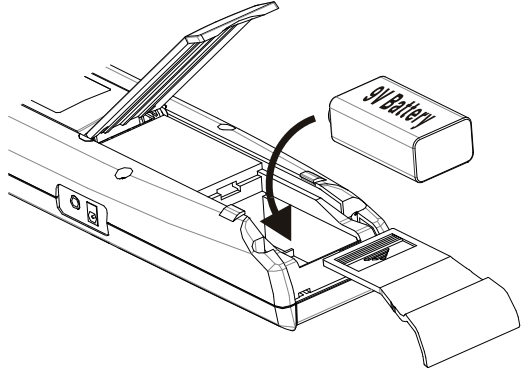

### 11.3 AC Adapter Connection

When the AC adapter is used, insert the plugs of the adapter into the DC9V connector on the side panel.

**Note:**

*When the AC adapter is connected while battery is inserted, the unit will be powered from the adapter (the AC adapter has priority).*

## 12. Maintenance

In order to ensure the accuracy of the thermometer for a longer period of time you should calibrate it once a year.

Clean the device and the window of the display with a clean, lint-free, antistatic and dry cleaning cloth.

**⚠** *Do not use cleaning agents that contain carbon or benzenes, alcohol or anything similar to clean the product since these substances damage the surface of the measuring instrument. Moreover, these fumes are hazardous to health and explosive. Do not use tools with sharp edges, screwdrivers, metal brushes or anything similar to clean the device.*

## 13. Temperature Probe

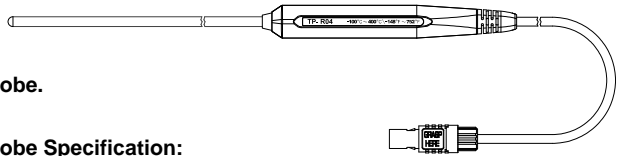

### 13.1 Piercing type temperature probe.

### 13.2 Piercing type temperature probe Specification:

Sensor Type	Platinum resistance thermometer sensor Pt 100(4 wires)
Accuracy	IEC751, class A (t: measurement temperature)
Measurement Range	-100 to 400°C
Temperature Sensor Dimensions	Approx. Ø5.0mm(Ø0.2")
Temperature Sensor Length	Approx. 230mm(9.05")
Cable Length	Approx. 1500mm(59.0")









---

**CENTER**<sup>®</sup> CENTER TECHNOLOGY CORP.

4 / F NO. 415, Jung-Jeng Rd., 238 Shu-Lin, Taipei, Taiwan

TEL: 886-2-26763926

E-Mail : center@centertek.com

FAX: 886-2-26763925

http : // www.centertek.com

GCA000376-12000

---