

UMB-Technology

A Passion for Precision

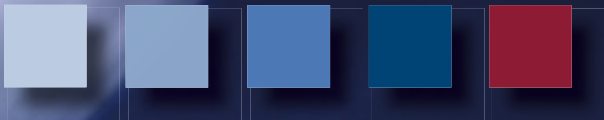

a passion for precision · passion pour la précision · pasión por la precisión · passione per la precisione · a passion for precision



www.umb-technology.info



Compact design
Easy commissioning
RS232 or RS485 data transfer
Easy software updates
Free configuration software

The Sky's the Limit

UMB



UMB Technology

The UMB (Universal Measurement Bus) system is a new technology for recording environmental data. Whether in the form of a standard weather station or road ice warning equipment, the modular system excels due to easy commissioning, free firmware updates and data transfer via RS232, RS485 or CDMA/GPRS modem. UMB offers flexibility, modularity and web-based visualization as well as polling software.

The UMB sensor library provides a comprehensive range of environmental sensors for recording temperature, relative humidity, precipitation, visibility and road conditions. The new WS series compact weather stations in particular are outstanding due to their unrivaled price-performance ratio. The top-of-the-range model, WS600-UMB, incorporates sensors for temperature, humidity, precipitation, air pressure, wind direction and wind speed.

The electrical connection for all UMB sensors is made via a standard plug connector system. This keeps installation and service costs to a minimum. Third party sensors and existing analog sensors can be integrated into the UMB system using the ANACON-UMB module.

All UMB sensors can be polled by means of a standard protocol. Once data polling has been incorporated for one sensor, additional sensors can be added by way of easy parameterization of the data polling system.

Channel-oriented sensor data polling delivers a large number of computed variables in metric and US format, hence there is no need for conversion by the user. Sensors can be configured, equipment tested and firmware updated with the free configuration software (UMBConfig-Tool).

In addition, Lufft offers a variety of software packages from data retrieval via weather stations (COLLECTOR) to web visualization (Smart-View3).

Third-Party-Sensors: The UMB technology is open and modular. Most of the analog sensor signals and many intelligent sensors of third parties can be integrated into Luffts UMB systems. The Lufft ANACON converts analog signals into UMB output. In case of intelligent (smart) sensors of third party suppliers, we integrate the corresponding sensor protocol into Luffts ISOCON to integrate the sensors into UMB output. Generally, every UMB application herewith can use the best combination of selected sensors.

Lufft UMB Sensor Overview



UMB-Sensor Overview

Integrated Sensors	WS601-UMB	WS600-UMB	WS504-UMB	WS503-UMB	WS502-UMB
Temperature	■	■	■	■	■
Rel. humidity	■	■	■	■	■
Precipitation type		■			
Precipitation intensity	■	■			
Rain accumulation	■	■			
Leaf wetness	■				
Air pressure	■	■	■	■	■
Wind direction	■	■	■	■	■
Wind speed	■	■	■	■	■
Electronic Compass	■	■			
Radiance (solar radiation)			■	■	■
Combination Options: Either a temperature sensor or rain sensor can be connected					
External Rain Sensor WTB 100			■	■	■
External Temperature Sensor WT1/WST1	■	■	■	■	■
External Leaf Surface Wetness Sensor WLW 100	■				
Third Party Rain Gauges compatible			■	■	■



UMB-Sensor Overview

Integrated Sensors	WS300-UMB	WS200-UMB	WTB100	VENTUS-UMB	V200A-UMB
Temperature	■				
Rel. humidity	■				
Precipitation type					
Precipitation intensity			■		
Rain accumulation			■		
Leaf wetness					
Air pressure	■			■	■
Wind direction		■		■	■
Wind speed		■		■	■
Electronic Compass		■			
Radiance (solar radiation)					
Combination Options: Either a temperature sensor or rain sensor can be connected					
External Rain Sensor WTB 100	■	■			
External Temperature Sensor WT1/WST1	■	■			
External Leaf Surface Wetness Sensor WLW 100					

Lufft UMB Sensor Overview

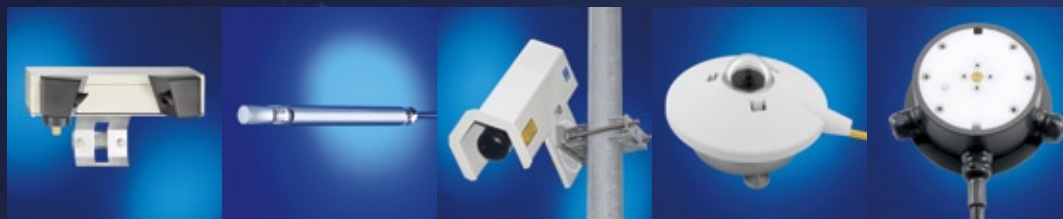

UMB-Sensor Overview					
	VS20-UMB	8160.TFF10/ ANACON-UMB	Snow Depth/ ANACON-UMB	CMP3 Pyranometer	ARS31-UMB
Temperature		■			The active sensor calculates the freeze point by means of cooling and heating cycles (Peltier element built in)
Rel. humidity		■			
Precipitation type					
Precipitation intensity					
Rain accumulation					
Leaf wetness					
Air pressure					
Wind direction					
Wind speed					
Electronic Compass					
Radiance (solar radiation)				■	
Visibility	■				
Snow height			■		



Protocol Overview: Data Output Standards	
	LCOM
European measurement units	■
American measurement units	■
TLS data types	■
TLS protocol	■
TLSoIP	■
NTCIP protocol	■
MSSI protocol	■
Synop	in preparation





ARS31Pro-UMB	IRS31-UMB	IRS21 / IRS21 CON	WST1 / WST2	NIRS31-UMB
<p>„All-in-one embedded road/runway sensor to measure freeze point temperature (active), road conditions and surface temperature. Including simulation of critical road conditions in the very near future</p>	<p>Road conditions, surface temperature, 2 depth temperatures, water film, ice %, freezing temperature</p>	<p>Road conditions, surface temperature, 2 depth temperatures, water film, freezing temperature</p>	<p>surface temperature</p>	<p>Road conditions, surface temperature, water film, ice %, freezing temperature, friction</p>



Lufft's high-quality networks for measuring emissions consist of gas measurements, dust particle measurements, as well as meteorological measurements.

Precision with UMB

The WS500-UMB and WS600-UMB deliver all meteorological measured data for Lufft's high-quality measuring networks. By means of the digital interface, they can be perfectly integrated into the measured data architecture of the entire system. When it comes to road traffic meteorology ("Green ITS"), quality is playing a more and more important role: In the future, traffic guidance and air pollution will depend on each other. This can only be realized with precise measured data, especially in large cities.



Lufft WS601-UMB – Temperature, Relative Humidity, Precipitation, Air Pressure, Wind, Electronic Compass

From the WS product family of professional intelligent measurement transducers with digital interface for environmental applications.

Integrated design with ventilated radiation protection for measuring:

- Air temperature
- Relative humidity
- Precipitation
- Air pressure
- Wind direction
- Wind speed

Relative humidity is measured by means of a capacitive sensor element; a precision NTC measuring element is used to measure air temperature.

Precipitation is measured by a tipping spoon and tipping bucket processes. The flexible tipping bucket allows a 0.2mm or a 0.5mm resolution of the rainfall.

Optionally, the WS601-UMB can be equipped with a leaf wetness sensor in addition.

Ultrasonic sensor technology is used to take wind measurements.

Measurement output can be accessed by the following protocols:
UMB-Binary, UMB-ASCII, SDI-12, MODBUS

One external temperature sensor is connectable.

Lufft WS601-UMB Compact Weather Station			Order No.
WS601-UMB			8376.U01
Technical Data	Dimensions	Ø approx. 164 mm, height approx. 445 mm	
	Weight	approx. 1.7 kg	
Temperature	Principle	NTC	
	Measuring range	-50 ... 60 °C	
	Accuracy	±0.2 °C (-20 °C ... +50 °C), otherwise ±0.5 °C (>-30 °C)	
Relative humidity	Principle	Capacitive	
	Measuring range	0 ... 100 % RH	
	Accuracy	±2 % RH	
Precipitation	Resolution	0.2mm / 0.5mm	
	Accuracy	±2 %	
Air pressure	Principle	MEMS capacitive	
	Measuring range	300 ... 1200 hPa	
	Accuracy	+/- 0.5 hPa (0...+40°C)	
Wind direction	Principle	Ultrasonic	
	Measuring range	0 ... 359.9 °	
	Accuracy	< 3 ° RMSE >1.0 m/s	
Wind speed	Principle	Ultrasonic	
	Measuring range	0 ... 30 m/s	
	Accuracy	±0.3 m/s or 3 % RMS	
General Information	Heating	20VA at 24 VDC	
	Protection type housing	IP66	
	Interface	RS485, 2-wire, half-duplex	
	Op. power consumption	24 VDC +/-10 % <0.4 VA (without heating)	
	Operating humidity range	0 ... 100 %	
	Op. temperature range	-50 ... 60 °C	
Accessories	Surge protection		8379.USP
	Power supply 24V/4A		8366.USV1
	UMB Interface converter ISOCON-UMB		8160.UISO
	Digital-analog-converter DACON8-UMB		8160.UDAC
	Leaf wetness sensor WLW100		8358.10
	Temperature Sensor WT1		8160.WT1
	Road Surface Temperature Sensor WST1		8160.WST1
	Connection cable, 20m		8370.UKAB20



All in One

Aspirated temperature/humidity measurement

Open communication protocol:

- UMB-ASCII
- UMB-Binary
- SDI-12
- MODBUS
- Analogue outputs in combination with 8160.UDAC

Lufft WS600-UMB – Temperature, Relative Humidity, Precipitation, Air Pressure, Wind, Electronic Compass

From the WS product family of professional intelligent measurement transducers with digital interface for environmental applications.

Integrated design with ventilated radiation protection for measuring:

- Air temperature
- Relative humidity
- Precipitation intensity
- Precipitation type
- Precipitation quantity
- Air pressure
- Wind direction
- Wind speed

Relative humidity is measured by means of a capacitive sensor element; a precision NTC measuring element is used to measure air temperature.

Precipitation is measured by a 24 GHz Doppler radar, which measures the drop speed of an individual drop of rain/snow.

Precipitation quantity and intensity are calculated from the correlation between drop size and speed.

The difference in drop speed determines the type of precipitation (rain/snow).

Maintenance-free measurement offers a major advantage over the common tipping spoon and tipping bucket processes.

Ultrasonic sensor technology is used to take wind measurements.

Measurement output can be accessed by the following protocols:
UMB-Binary, UMB-ASCII, SDI-12, MODBUS

One external temperature sensor is connectable.

All in One

Aspirated temperature/humidity measurement

Maintenance-free operation

Open communication protocol:

- UMB-ASCII
- UMB-Binary
- SDI-12
- MODBUS

- Analogue outputs in combination with 8160.UDAC

Lufft WS600-UMB Compact Weather Station			Order No.
WS600-UMB EU, USA, Canada			8370.U01
WS600-UMB UK			8370.U02
Technical Data	Dimensions	Ø approx. 150mm, height approx. 343 mm	
	Weight	approx. 1.5 kg	
Temperature	Principle	NTC	
	Measuring range	-50 ... 60 °C	
	Accuracy	±0.2 °C (-20 °C ... +50 °C), otherwise ±0.5 °C (> -30 °C)	
Relative humidity	Principle	Capacitive	
	Measuring range	0 ... 100 % RH	
	Accuracy	±2 % RH	
Precipitation intensity	Resolution	0.01 mm	
	Measuring range	Drop size 0.3 ... 5 mm	
	Reproducibility	typ. >90 %	
Precipitation type	Rain/snow		
Air pressure	Principle	MEMS capacitive	
	Measuring range	300 ... 1200 hPa	
	Accuracy	+/- 0.5 hPa (0...+40°C)	
Wind direction	Principle	Ultrasonic	
	Measuring range	0 ... 359.9°	
	Accuracy	< 3° RMSE >1.0 m/s	
Wind speed	Principle	Ultrasonic	
	Measuring range	0 ... 60 m/s	
	Accuracy	±0.3 m/s or 3 % (0 ... 35 m/s) RMS of reading, whichever is greater ±5 % (> 35 m/s) RMS	
General Information	Heating	40 VA at 24 VDC	
	Protection type housing	IP66	
	Interface	RS485, 2-wire, half-duplex	
	Op. power consumption	24 VDC +/-10 %	
	Operating humidity range	0 ... 100 %	
	Op. temperature range	-50 ... 60 °C	
Accessories	Surge protection		8379.USP
	Power supply 24V/4A		8366.USV1
	UMB Interface converter ISOCON-UMB		8160.UISO
	Digital-analog-converter DACON8-UMB		8160.UDAC
	Temperature Sensor WT1		8160.WT1
	Road Surface Temperature Sensor WST1		8160.WST1
	Connection cable, 20m		8370.UKAB20



Lufft WS502-UMB – Temperature, Relative Humidity, Radiation, Air Pressure, Wind, Electronic Compass

From the WS product family of professional intelligent measurement transducers with digital interface for environmental applications.

Integrated design with ventilated radiation protection for measuring:

- Air temperature
- Relative humidity
- Air pressure
- Wind direction
- Wind speed
- Solar Radiation

Relative humidity is measured by means of a capacitive sensor element; a precision NTC measuring element is used to measure air temperature.

Ultrasonic sensor technology is used to take wind measurements.

Measurement output can be accessed by the following protocols:
UMB-Binary, UMB-ASCII, SDI-12, MODBUS

One external temperature or rain sensor is connectable.

Lufft WS502-UMB Compact Weather Station			Order No.
WS502-UMB			8375.U10
Technical Data	Dimensions	Ø approx. 150mm, height 317 mm	
	Weight	approx. 1.5 kg	
Temperature	Principle	NTC	
	Measuring range	-50 ... 60 °C	
	Accuracy	±0.2 °C (-20 °C ... +50 °C), otherwise ±0.5 °C (> -30 °C)	
Relative humidity	Principle	Capacitive	
	Measuring range	0 ... 100 % RH	
	Accuracy	±2 % RH	
Radiation	Response time (95%)	< 1s	
	Spectral range	300 to 1100 nm	
	Measuring range	1400 W/m ²	
Air pressure	Principle	MEMS capacitive	
	Measuring range	300 ... 1200 hPa	
	Accuracy	+/- 0.5 hPa (0...+40°C)	
Wind direction	Principle	Ultrasonic	
	Measuring range	0 ... 359.9°	
	Accuracy	< 3° RMSE >1.0 m/s	
Wind speed	Principle	Ultrasonic	
	Measuring range	0 ... 60 m/s	
	Accuracy	±0.3 m/s or 3% (0...35 m/s) RMS of reading, whichever is greater ±5% (>35 m/s) RMS	
General Information	Heating	20VA at 24 VDC	
	Protection type housing	IP66	
	Interface	RS485, 2-wire, half-duplex	
	Operating power consumption	24 VDC +/- 10 %	
	Operating humidity range	0 ... 100 %	
Accessories	Operating temperature range	-50 ... 60 °C	
	Surge protection		8379.USP
	Power supply 24V/4A		8366.USV1
	UMB Interface converter ISOCON-UMB		8160.UISO
	Digital-analog-converter DACON8-UMB		8160.UDAC
	Temperature Sensor WT1		8160.WT1
	Road Surface Temperature Sensor WST1		8160.WST1
	Rain Sensor WTB100		8353.10
Connection cable, 20m		8370.UKAB20	

All in One

Aspirated temperature/humidity measurement

Open communication protocol:

- UMB-ASCII
- UMB-Binary
- SDI-12
- MODBUS

- Analogue outputs in combination with 8160.UDAC

Third-Party-Rain gauge sensors are compatible: 0.1 mm, 0.2 mm, 0.5 mm, 1mm heated and unheated.



Luffts family of digital weather sensors for all environmental applications: best precision, solar- or mains-powered, all-in-one and stand-alone versions, open interfaces, long life cycle

Smart Sensors

WS Family



Lufft WS501-UMB – Temperature, Relative Humidity, Radiation, Air Pressure, Wind, Electronic Compass

From the WS product family of professional intelligent measurement transducers with digital interface for environmental applications.

Integrated design with ventilated radiation protection for measuring:

- Air temperature
- Relative humidity
- Air pressure
- Wind direction
- Wind speed
- Solar Radiation

Relative humidity is measured by means of a capacitive sensor element; a precision NTC measuring element is used to measure air temperature.

The world renowned technology of Kipp+Zonen CMP3 is integrated.

Ultrasonic sensor technology is used to take wind measurements.

Measurement output can be accessed by the following protocols:
UMB-Binary, UMB-ASCII, SDI-12, MODBUS

One external temperature or rain sensor is connectable.

Lufft WS501-UMB Compact Weather Station		Order No.
WS501-UMB EU, USA, Canada		8375.U01
Technical Data	Dimensions	Ø approx. 150 mm, height 332 mm
	Weight	approx. 1.5 kg
Temperature	Principle	NTC
	Measuring range	-50 ... 60 °C
	Accuracy	±0.2 °C (-20 °C ... +50 °C), otherwise ±0.5 °C (>-30 °C)
Relative humidity	Principle	Capacitive
	Measuring range	0 ... 100 % RH
	Accuracy	±2 % RH
Radiation	Response time (95%)	< 18s
	Non-stability (change/year)	< 1%
	Non-linearity (0 to 1,000 W/m²)	< 1%
	Directional error (at 80° with 1,000 W/m²)	< 20 W/m²
	Temperature dependence of sensitivity	< 5 % (-10 to +40 °C)
	Tilt error (at 1000 W/m²)	< 1%
	Spectral range (50% points)	300 to 2,800 nm
	Measuring range	1400 W/m²
Air pressure	Principle	MEMS capacitive
	Measuring range	300 ... 1200 hPa
	Accuracy	+/- 0.5 hPa (0...+40°C)
Wind direction	Principle	Ultrasonic
	Measuring range	0 ... 359.9°
	Accuracy	< 3° RMSE >1.0 m/s
Wind speed	Principle	Ultrasonic
	Measuring range	0 ... 60 m/s
General Information	Accuracy	±0.3 m/s or 3% (0...35 m/s) RMS of reading, whichever is greater ±5% (>35 m/s) RMS
	Heating	20 VA at 24 VDC
	Protection type housing	IP66
	Interface	RS485, 2-wire, half-duplex
	Operating power consumption	24VDC +/-10%
	Operating humidity range	0 ... 100%
Operating temperature range	-50 ... 60 °C	
Accessories	Surge protection	8379.USP
	Power supply 24V/4A	8366.USV1
	UMB Interface converter ISOCON-UMB	8160.UISO
	Digital-analog-converter DACON8-UMB	8160.UDAC
	Temperature Sensor WT1	8160.WT1
	Road Surface Temperature Sensor WST1	8160.WST1
	Connection cable, 20m	8370.UKAB20
	Rain Sensor WTB100	100 8353.10



All in One

Aspirated temperature/humidity measurement

Open communication protocol:

- UMB-ASCII
- UMB-Binary
- SDI-12
- MODBUS
- Analogue outputs in combination with 8160.UDAC

Third-Party-Rain gauge sensors are compatible: 0.1 mm, 0.2 mm, 0.5 mm, 1mm heated and unheated.



Lufft WS503-UMB – Tilttable Pyranometer, Wind, Temperature, Air Pressure, Relative Humidity, Electronic Compass

From the WS product family of professional intelligent measurement transducers with digital interface for environmental applications.

Integrated design with ventilated radiation protection for measuring:

- Air temperature
- Relative humidity
- Air pressure
- Wind direction
- Wind speed
- Solar Radiation

Relative humidity is measured by means of a capacitive sensor element; a precision NTC measuring element is used to measure air temperature.

The world renowned technology of Kipp+Zonen CMP3 is integrated.

Ultrasonic sensor technology is used to take wind measurements.

Measurement output can be accessed by the following protocols:
UMB-Binary, UMB-ASCII, SDI-12, MODBUS.

One external temperature or rain sensor is connectable.



Tilttable Pyranometer

Ultrasonic wind sensor

Aspirated temperature/humidity measurement

Open communication protocol:

- UMB-ASCII
- UMB-Binary
- SDI-12
- MODBUS
- Analogue outputs in combination with 8160.UDAC

Third-Party-Rain gauge sensors are compatible: 0.1 mm, 0.2 mm, 0.5 mm, 1mm heated and unheated.

Lufft WS503-UMB Compact Weather Station			Order No.
WS503-UMB EU, USA, Canada			8375.U11
Technical Data	Dimensions	Ø approx. 150 mm, height 392mm	
	Weight	approx. 1.5 kg	
Temperature	Principle	NTC	
	Measuring range	-50 ... 60 °C	
	Accuracy	±0.2 °C (-20 °C ... +50 °C), otherwise ±0.5 °C (>-30 °C)	
Relative humidity	Principle	Capacitive	
	Measuring range	0 ... 100 % RH	
	Accuracy	±2 % RH	
Radiation	Response time (95%)	< 18s	
	Non-stability (change/year)	< 1%	
	Non-linearity (0 to 1,000 W/m²)	< 1%	
	Directional error (at 80° with 1,000 W/m²)	< 20W/m²	
	Temperature dependence of sensitivity	< 5% (-10 bis +40 °C)	
	Tilt error (at 1000 W/m²)	< 1%	
	Spectral range (50% points)	300 to 2,800 nm	
	Measuring range	1400 W/m²	
Air pressure	Altitude	0...60°	
	Azimuth	-10° ... +10°	
	Principle	MEMS capacitive	
Wind direction	Measuring range	300 ... 1200 hPa	
	Accuracy	±0.5 hPa (0 ... +40°C)	
	Principle	Ultrasonic	
Wind speed	Measuring range	0 ... 359.9°	
	Accuracy	< 3° RMSE >1.0 m/s	
	Principle	Ultrasonic	
General Information	Measuring range	0 ... 60 m/s	
	Accuracy	±0.3 m/s or 3% (0...35 m/s) RMS of reading, whichever is greater ±5% (>35 m/s) RMS	
	Heating	20 VA at 24VDC	8379.USP
	Protection type housing	IP66	8366.USV1
	Interface	RS485, 2-wire, half-duplex	8160.UISO
Accessories	Operating power consumption	24VDC +/-10%	8160.UDAC
	Operating humidity range	0 ... 100 %	8160.WT1
	Operating temperature range	-50 ... 60 °C	8160.WST1
	Surge protection		8370.UKAB20
	Power supply 24V/4A		8353.10
	UMB Interface converter ISOCON-UMB		
	Digital-analog-converter DAICON8-UMB		
Temperature Sensor WT1			
Road Surface Temperature Sensor WST1			
Connection cable, 20m			
Rain Sensor WTB100			



Lufft WS504-UMB – Tiltable Pyranometer, Wind, Temperature, Air Pressure, Relative Humidity, Electronic Compass

From the WS product family of professional intelligent measurement transducers with digital interface for environmental applications.

Integrated design with ventilated radiation protection for measuring:

- Air temperature
- Relative humidity
- Air pressure
- Wind direction
- Wind speed
- Solar Radiation

Relative humidity is measured by means of a capacitive sensor element; a precision NTC measuring element is used to measure air temperature.

Ultrasonic sensor technology is used to take wind measurements.

Measurement output can be accessed by the following protocols:
UMB-Binary, UMB-ASCII, SDI-12, MODBUS .

One external temperature or rain sensor is connectable.

Lufft WS504-UMB Compact Weather Station			Order No.
WS504-UMB			8375.U12
Technical Data	Dimensions	Ø approx. 150mm, height 377 mm	
	Weight	approx. 1.5 kg	
Temperature	Principle	NTC	
	Measuring range	-50 ... 60 °C	
	Accuracy	±0.2 °C (-20 °C ... +50 °C), otherwise ±0.5 °C (> -30 °C)	
Relative humidity	Principle	Capacitive	
	Measuring range	0 ... 100 % RH	
	Accuracy	±2 % RH	
Radiation	Response time (95%)	< 1s	
	Spectral range	300 to 1100 nm	
	Measuring range	1400 W/m ²	
Air pressure	Principle	MEMS capacitive	
	Measuring range	300 ... 1200 hPa	
	Accuracy	±0.5 hPa (0 ... +40 °C)	
Wind direction	Principle	Ultrasonic	
	Measuring range	0 ... 359.9 °	
	Accuracy	< 3 ° RMSE >1.0 m/s	
Wind speed	Principle	Ultrasonic	
	Measuring range	0 ... 60 m/s	
	Accuracy	±0.3 m/s or 3 % (0 ... 35 m/s) RMS of reading, whichever is greater ±5 % (> 35 m/s) RMS	
General Information	Heating	20 VA at 24 VDC	
	Protection type housing	IP66	
	Interface	RS485, 2-wire, half-duplex	
	Operating power consumption	24 VDC +/- 10 %	
	Operating humidity range	0 ... 100 %	
Accessories	Operating temperature range	-50 ... 60 °C	
	Surge protection		8379.USP
	Power supply 24V/4A		8366.USV1
	UMB Interface converter ISOCON-UMB		8160.UISO
	Digital-analog-converter DAICON8-UMB		8160.UDAC
	Temperature Sensor WT1		8160.WT1
	Road Surface Temperature Sensor WST1		8160.WST1
	Rain Sensor WTB100		8353.10
Connection cable, 20m		8370.UKAB20	



All in One

Aspirated temperature/humidity measurement

Open communication protocol:

- UMB-ASCII
- UMB-Binary
- SDI-12
- MODBUS

- Analogue outputs in combination with 8160.UDAC

Third-Party-Rain gauge sensors are compatible: 0.1 mm, 0.2 mm, 0.5 mm, 1mm heated and unheated.



Lufft WS500-UMB – Temperatur, relative Feuchte, Luftdruck, Wind, elektronischer Kompass

Aus der WS-Produktfamilie der professionellen intelligenten Messwertgeber mit digitaler Schnittstelle für Umweltsanwendungen.

Integrierte Konstruktion mit belüftetem Strahlenschutz zur Messung von:

- Lufttemperatur
- Relative Feuchte
- Luftdruck
- Windrichtung
- Windgeschwindigkeit

Die relative Feuchte wird mittels eines kapazitiven Sensorelements erfasst, die Lufttemperatur mit einem präzisen NTC-Messelement.

Die Windmessung erfolgt mit Ultraschall-Sensorik.

Die Messdatenausgabe unterstützt die Protokolle: UMB-Binär, UMB-ASCII, SDI-12, MODBUS

One external temperature or rain sensor is connectable.

Lufft WS500-UMB Compact Weather Station			Order No.
WS500-UMB			8373.U01
Technical Data	Dimensions	Ø approx. 150mm, height approx 287mm	
	Weight	approx. 1.2kg	
Temperature	Principle	NTC	
	Measuring range	-50 ... 60 °C	
	Accuracy	±0.2 °C (-20 °C ... +50 °C), otherwise ±0.5 °C (> -30 °C)	
Relative humidity	Principle	Capacitive	
	Measuring range	0 ... 100 % RH	
	Accuracy	±2 % RH	
Air pressure	Principle	MEMS Capacitive	
	Measuring range	300 ... 1200 hPa	
	Accuracy	+/- 0.5 hPa (0...+40°C)	
Wind direction	Principle	Ultrasonic	
	Measuring range	0 ... 359.9°	
	Accuracy	< 3° RMSE >1.0 m/s	
Wind speed	Principle	Ultrasonic	
	Measuring range	0 ... 60 m/s	
	Accuracy	±0.3 m/s or 3 % (0 ... 35 m/s) RMS of reading, whichever is greater ±5 % (>35 m/s) RMS	
General Information	Heating	20 VA at 24 VDC	
	Protection type housing	IP66	
	Interface	RS485, 2-wire, half-duplex	
	Op. power consumption	24 VDC +/- 10 %	
	Operating humidity range	0 ... 100 %	
	Op. temperature range	-50 ... 60 °C	
Accessories	Surge protection		8379.USP
	Power supply 24V/4A		8366.USV1
	UMB Interface converter ISOCON-UMB		8160.UISO
	Traverse for R2S-UMB + WS500-UMB		8367.TRAV
	Digital-analog-converter DACON8-UMB		8160.UDAC
	Temperature Sensor WT1		8160.WT1
	Road Surface Temperature Sensor WST1		8160.WST1
	Rain Sensor WTB100		8353.10
	Connection cable, 20m		8370.UKAB20



Ultrasonic wind sensor

Aspirated temperature/humidity measurement

Open communication protocol:

- UMB-ASCII
- UMB-Binary
- SDI-12
- MODBUS

- Analogue outputs in combination with 8160.UDAC

Third-Party-Rain gauge sensors are compatible: 0.1 mm, 0.2 mm, 0.5 mm, 1mm heated and unheated.



Lufft WS401-UMB – Temperature, Relative Humidity, Precipitation, Air Pressure

From the WS product family of professional intelligent measurement transducers with digital interface for environmental applications.

Integrated design with ventilated radiation protection for measuring:

- Air temperature
- Relative humidity
- Precipitation
- Air pressure

Relative humidity is measured by means of a capacitive sensor element; a precision NTC measuring element is used to measure air temperature.

Optionally, the WS401-UMB can be equipped with a leaf wetness sensor in addition.

Precipitation is measured by tipping spoon and tipping bucket processes. The flexible tipping bucket allows a 0.2mm or a 0.5mm resolution of the rainfall.

Measurement output can be accessed by the following protocols:
UMB-Binary, UMB-ASCII, SDI-12, MODBUS

One external temperature sensor is connectable.

Lufft WS401-UMB Compact Weather Station			Order No.
WS401-UMB			8377.U01
Technical Data	Dimensions	Ø approx. 150mm, height approx. 380mm	
	Weight	approx. 1.5kg	
Temperature	Principle	NTC	
	Measuring range	-50 ... 60 °C	
	Accuracy	±0.2 °C (-20 °C... +50 °C), otherwise ±0.5 °C (> -30 °C)	
Relative humidity	Principle	Capacitive	
	Measuring range	0 ... 100 % RH	
	Accuracy	±2 % RH	
Precipitation	Resolution	0.2 mm / 0.5mm	
	Accuracy	±2 %	
Air pressure	Principle	MEMS Capacitive	
	Measuring range	300 ... 1200hPa	
	Accuracy	+/- 0.5 hPa (0...+40°C)	
General Information	Protection type housing	IP66	
	Interface	RS485, 2-wire, half-duplex	
	Op. power consumption	24VDC +/-10% <0.4VA (without heating)	
	Operating humidity range	0 ... 100 %	
	Op. temperature range	-50 ... 60 °C	
Accessories	Surge protection		8379.USP
	Power supply 24V/4A		8366.USV1
	UMB Interface converter ISOCON-UMB		8160.UISO
	Digital-analog-converter DACON8-UMB		8160.UDAC
	Leaf wetness sensor WLW100		8358.10
	Temperature Sensor WT1		8160.WT1
	Road Surface Temperature Sensor WST1		8160.WST1
	Connection cable, 20m		8370.UKAB20



Aspirated temperature/humidity measurement

Open communication protocol:

- UMB-ASCII
- UMB-Binary
- SDI-12
- MODBUS
- Analogue outputs in combination with 8160.UDAC

Lufft WS400-UMB – Temperature, Relative Humidity, Precipitation, Air Pressure

From the WS product family of professional intelligent measurement transducers with digital interface for environmental applications.

Integrated design with ventilated radiation protection for measuring:

- Air temperature
- Relative humidity
- Precipitation intensity
- Precipitation type
- Precipitation quantity
- Air pressure

Relative humidity is measured by means of a capacitive sensor element; a precision NTC measuring element is used to measure air temperature.

Precipitation is measured by a 24 GHz Doppler radar, which measures the drop speed of an individual drop of rain/snow.

Precipitation quantity and intensity are calculated from the correlation between drop size and speed.

The difference in drop speed determines the type of precipitation (rain/snow). Maintenance-free measurement offers a major advantage over the common tipping spoon and tipping bucket processes.

Measurement output can be accessed by the following protocols:
UMB-Binary, UMB-ASCII, SDI-12, MODBUS

One external temperature sensor is connectable.

Lufft WS400-UMB Compact Weather Station			Order No.
WS400-UMB EU, USA, Canada			8369.U01
WS400-UMB UK			8369.U02
Technical Data	Dimensions	Ø approx. 150mm, height approx. 280mm	
	Weight	approx. 1.3kg	
Temperature	Principle	NTC	
	Measuring range	-50...60°C	
	Accuracy	±0.2°C (-20°C...+50°C), otherwise ±0.5°C (>-30°C)	
Relative humidity	Principle	Capacitive	
	Measuring range	0...100% RH	
	Accuracy	±2% RH	
Precipitation intensity	Resolution	0.01mm	
	Measuring range	Measuring range drop size 0.3...5mm	
	Reproducibility	typ. >90%	
Precipitation type	Rain/snow		
Air pressure	Principle	MEMS Capacitive	
	Measuring range	300...1200hPa	
	Accuracy	+/- 0.5 hPa (0...+40°C)	
General Information	Heating	20VA at 24VDC	
	Protection type housing	IP66	
	Interface	RS485, 2-wire, half-duplex	
	Op. power consumption	24VDC +/-10%	
	Operating humidity range	0...100%	
	Op. temperature range	-50...60°C	
Accessories	Surge protection		8379.USP
	Power supply 24V/4A		8366.USV1
	UMB Interface converter ISOCON-UMB		8160.UISO
	Digital-analog-converter DACON8-UMB		8160.UDAC
	Temperature Sensor WT1		8160.WT1
	Road Surface Temperature Sensor WST1		8160.WST1
	Connection cable, 20m		8370.UKAB20



Aspirated temperature/humidity measurement

Maintenance-free operation

Open communication protocol:

- UMB-ASCII
- UMB-Binary
- SDI-12
- MODBUS
- Analogue outputs in combination with 8160.UDAC

Lufft WS302-UMB – Temperature, Relative Humidity, Radiation, Air Pressure

From the WS product family of professional intelligent measurement transducers with digital interface for environmental applications.

Integrated design with ventilated radiation protection for measuring:

- Air temperature
- Relative humidity
- Solar radiation
- Air pressure

Relative humidity is measured by means of a capacitive sensor element; a precision NTC measuring element is used to measure air temperature.

Measurement output can be accessed by the following protocols:
UMB-Binary, UMB-ASCII, SDI-12, MODBUS

One external temperature or rain sensor is connectable.

Lufft WS302-UMB Compact Weather Station			Order No.
WS302-UMB			8374.U10
Technical Data	Dimensions	Ø approx. 150 mm, height 253 mm	
	Weight	approx. 1.3 kg	
Temperature	Principle	NTC	
	Measuring range	-50 ... 60 °C	
	Accuracy	±0.2 °C (-20 °C ... +50 °C), otherwise ±0.5 °C (> -30 °C)	
Relative humidity	Principle	Capacitive	
	Measuring range	0 ... 100 % RH	
	Accuracy	±2 % RH	
Radiation	Response time (95%)	< 1 s	
	Spectral range	300 to 1100 nm	
	Measuring range	1400 W/ m ²	
Air pressure	Principle	MEMS Capacitive	
	Measuring range	300 ... 1200 hPa	
	Accuracy	+/- 0.5 hPa (0...+40°C)	
General Information	Protection type housing	IP66	
	Interface	RS485, 2-wire, half-duplex	
	Op. power consumption	24VDC +/-10%	
	Operating humidity range	0 ... 100 %	
	Op. temperature range	-50 ... 60 °C	
Accessories	Surge protection		8379.USP
	Power supply 24V/4A		8366.USV1
	UMB Interface converter ISOCON-UMB		8160.UISO
	Digital-analog-converter DACON8-UMB		8160.UDAC
	Temperature Sensor WT1		8160.WT1
	Road Surface Temperature Sensor WST1		8160.WST1
	Rain Sensor WTB100		8353.10
	Connection cable, 20m		8370.UKAB20



Aspirated temperature/humidity measurement

Open communication protocol:

- UMB-ASCII
- UMB-Binary
- SDI-12
- MODBUS

- Analogue outputs in combination with 8160.UDAC

Third-Party-Rain gauge sensors are compatible: 0.1 mm, 0.2 mm, 0.5 mm, 1mm heated and unheated.



Lufft WS301-UMB – Temperature, Relative Humidity, Radiation, Air Pressure

From the WS product family of professional intelligent measurement transducers with digital interface for environmental applications.

Integrated design with ventilated radiation protection for measuring:

- Air temperature
- Relative humidity
- Solar radiation
- Air pressure

Relative humidity is measured by means of a capacitive sensor element; a precision NTC measuring element is used to measure air temperature.

The world renowned technology of Kipp+Zonen CMP3 is integrated.

Measurement output can be accessed by the following protocols:
UMB-Binary, UMB-ASCII, SDI-12, MODBUS

One external temperature or rain sensor is connectable.

Lufft WS301-UMB Compact Weather Station			Order No.
WS301-UMB			8374.U01
Technical Data	Dimensions	Ø approx. 150mm, height 268mm	
	Weight	approx. 1.3kg	
Temperature	Principle	NTC	
	Measuring range	-50... 60 °C	
	Accuracy	±0.2 °C (-20 °C... +50 °C), otherwise ±0.5 °C (> -30 °C)	
Relative humidity	Principle	Capacitive	
	Measuring range	0... 100 % RH	
	Accuracy	±2 % RH	
Radiation	Response time (95%)	< 18s	
	Non-stability (change/year)	< 1%	
	Non-linearity (0 to 1,000 W/m²)	< 1%	
	Directional error (at 80 ° with 1,000W/m²)	< 20W/m²	
	Temperature dependent of sensitivity	< 5% (-10 bis +40 ° C)	
	Tilt error (at 1000W/m²)	< 1%	
	Spectral range (50% points)	300 to 2,800nm	
Air pressure	Measuring range	1400W/ m²	
	Principle	MEMS Capacitive	
	Measuring range	300... 1200hPa	
General Information	Accuracy	±0.5 hPa (0... +40°C)	
	Protection type housing	IP66	
	Interface	RS485, 2-wire, half-duplex	
	Op. power consumption	24VDC +/-10 %	
	Operating humidity range	0... 100 %	
Accessories	Op. temperature range	-50... 60 °C	
	Surge protection		8379.USP
	Power supply 24V/4A		8366.USV1
	UMB Interface converter ISOCON-UMB		8160.UISO
	Digital-analog-converter DAICON8-UMB		8160.UDAC
	Temperature Sensor WT1		8160.WT1
	Road Surface Temperature Sensor WST1		8160.WST1
	Rain Sensor WTB100		8353.10
Connection cable, 20m		8370.UKAB20	



Aspirated temperature/humidity measurement

Open communication protocol:

- UMB-ASCII
- UMB-Binary
- SDI-12
- MODBUS

- Analogue outputs in combination with 8160.UDAC

Third-Party-Rain gauge sensors are compatible: 0.1 mm, 0.2 mm, 0.5 mm, 1mm heated and unheated.



Lufft WS300-UMB – Temperature, Air Pressure, Relative Humidity

From the WS product family of professional intelligent measurement transducers with digital interface for environmental applications.

Integrated design with ventilated radiation protection for measuring:

- Air temperature
- Relative humidity
- Air pressure

Relative humidity is measured by means of a capacitive sensor element; a precision NTC measuring element is used to measure air temperature.

Measurement output can be accessed by the following protocols:
UMB-Binary, UMB-ASCII, SDI-12, MODBUS

One external temperature or rain sensor is connectable.

Lufft WS300-UMB Compact Weather Station			Order No.
WS300-UMB			8372.U01
Technical Data	Dimensions	Ø approx. 150 mm, height approx. 223 mm	
	Weight	approx. 1.0 kg	
Temperature	Principle	NTC	
	Measuring range	-50 ... 60 °C	
	Accuracy	±0.2 °C (-20 °C ... +50 °C), otherwise ±0.5 °C (> -30 °C)	
Relative humidity	Principle	Capacitive	
	Measuring range	0 ... 100 % RH	
	Accuracy	±2 % RH	
Air pressure	Principle	MEMS Capacitive	
	Measuring range	300 ... 1200 hPa	
	Accuracy	±0.5 hPa (0 ... +40 °C)	
General Information	Interface	RS485, 2-wire, half-duplex	
	Protection type housing	IP66	
	Op. power consumption	24 VDC +/- 10% < 0.4 VA	
	Operating humidity range	0 ... 100 %	
	Op. temperature range	-50 ... 60 °C	
Accessories	Surge protection		8379.USP
	Power supply 24V/4A		8366.USV1
	UMB Interface converter ISOCON-UMB		8160.UISO
	Digital-analog-converter DACON8-UMB		8160.UDAC
	Temperature Sensor WT1		8160.WT1
	Road Surface Temperature Sensor WST1		8160.WST1
	Rain Sensor WTB100		8353.10
	Connection cable, 20m		8370.UKAB20

Aspirated temperature/humidity measurement

Open communication protocol:

- UMB-ASCII
- UMB-Binary
- SDI-12
- MODBUS
- Analogue outputs in combination with 8160.UDAC

Third-Party-Rain gauge sensors are compatible: 0.1 mm, 0.2 mm, 0.5 mm, 1mm heated and unheated.



Lufft WS200-UMB – Ultrasonic Wind Sensor, Electronic Compass

From the WS product family of professional intelligent measurement transducers with digital interface for environmental applications.

Integrated design for measuring:

- Wind direction
- Wind speed

Ultrasonic sensor technology is used to take wind measurements.

Measurement output can be accessed by the following protocols:
UMB-Binary, UMB-ASCII, SDI-12, MODBUS

One external temperature or rain sensor is connectable.

Lufft WS200-UMB Compact Weather Station			Order No.
WS200-UMB			8371.U01
Technical Data	Dimensions	Ø approx. 150mm, height approx. 194mm	
	Weight	approx. 0.8 kg	
Wind direction	Principle	Ultrasonic	
	Measuring range	0 ... 359.9°	
	Accuracy	< 3° RMSE >1.0m/s	
Wind speed	Principle	Ultrasonic	
	Measuring range	0 ... 60m/s	
	Accuracy	±0.3 m/s or 3% (0... 35 m/s) RMS of reading, whichever is greater ±5% (>35 m/s) RMS	
General Information	Heating	20VA at 24VDC	
	Protection type housing	IP66	
	Interface	RS485, 2-wire, half-duplex	
	Op. power consumption	24VDC +/-10%	
	Operating humidity range	0 ... 100%	
	Op. temperature range	-50 ... 60°C	
Accessories	Surge protection		8379.USP
	Power supply 24V/4A		8366.USV1
	UMB Interface converter ISOCON-UMB		8160.UISO
	Digital-analog-converter DACON8-UMB		8160.UDAC
	Temperature Sensor WT1		8160.WT1
	Road Surface Temperature Sensor WST1		8160.WST1
	Rain Sensor WTB100		8353.10
	Connection cable, 20m		8370.UKAB20



Ultrasonic wind measurement

Open communication protocol:

- UMB-ASCII
- UMB-Binary
- SDI-12
- MODBUS
- Analogue outputs in combination with 8160.UDAC

Third-Party-Rain gauge sensors are compatible: 0.1 mm, 0.2 mm, 0.5 mm, 1mm heated and unheated.

Lufft Snow Depth Sensor

Lufft Snow Depth Sensor		Bestell-Nr.
A compact laser sensor for determining snow depths		8365.10
Technical Data	Dimensions	302mm x 130mm x 234mm
	Weight	approx. 3.3kg
	Snow depth	0...15m (0...50ft)
	Accuracy	< ±5mm
	Progr. measuring interval	10...600s
	Time to measure	0.16...6s
	Distance range	0.1...15m
	Data interfaces	RS232, analog output
	Interfaces modes RS232	2.4...38,4kBaud, 8N1 Format
	analog	4...20mA
	Power consumption	0.5...1W (without heating) <12W (with heating, @-40°C)
	Power supply	10...30VDC (without heating) 15...24VDC (with heating)
	Laser classification	Class 2 (EN 60825-1:2007)
	International protection	IP65
	Temperature range	-40...+50°C
Relative humidity	0...100%	
Heating activity	<0°C programmable	



Lufft WTB100 External Rain Gauge

Lufft WTB100 Rain Gauge		Order No.
Rain gauge 0.2 mm unheated		8353.10
Technical Data	Dimensions	Ø165 mm, height 255 mm
	Connection type	Open cable ends
	Collecting area	200 cm ²
	Resolution	0.2 mm and 0.5 mm (tipping bucket)
	Dimensions	380 g
	Mounting type	On mast, Ø 60-76 mm





Passed:
Ice-free test
Jarring test
Corrosion test

A Passion for Precision Ventus

VENTUS ultrasonic cold weather anemometer was tested under MIL standard-810F method 521.2 proving success in ice free operation.

Ventus is corrosion tested for seawater and vibration resistance. It gives the best accuracy with maintenance-free operation.

*Now UL-certified
Underwriters Laboratories Inc.*



Lufft VENTUS-UMB– Ultrasonic Wind Sensor Metal Housing, 240W-Heater



Extremely precise and maintenance-free measurement of wind velocity and wind direction, as well as calculation of acoustic virtual temperature.

Belongs to Lufft's WS family of professional intelligent sensors with digital and analog interfaces.

The ultrasonic wind sensor is designed without mechanical parts – traditionally known as "cups and vane".

The digital or analog output delivers instantaneous, average, min or max value with flexible measuring rate. The VENTUS is heated in case of critical ambient conditions. Made for cold climates!

Recommended for:

- Wind turbines
- Marine/ships
- Meteorology
- Building automation

The following outputs/protocols are available:

- NMEA
- UMB-ASCII
- UMB-Binary
- MODBUS (ASCII, RTU)
- SDI-12
- 4 ... 20 mA, 0...10V, 0...20 mA, 2...10V frequency (analog)

Halttest

- Vibration test** According to IEC 60945
Corrosion test According to MIL-STD-810 Method 509.3
Ice-free test According to MIL-STD-810F Method 521.2

Lufft VENTUS-UMB Wind Sensor		Order No.
VENTUS-UMB		8371.UM
VENTUS-UMB for wind energy applications		8371.UMT
Technical Data	Dimensions	Ø approx. 150mm, height approx. 170mm
	Weight	approx. 1.62 kg
Wind direction	Principle	Ultrasonic
	Measuring range	0 ... 359.9°
	Resolution	0.1°
	Accuracy	<2° RMSE >1.0 m/s
	Start-up threshold	0.1 m/s
	Measuring rate	60 partial measurements/ 15 measurements per second
	Measurement output rate	1-10 seconds adjustable – default 10 s
Wind speed	Principle	Ultrasonic
	Measuring range	0 ... 75 m/s
	Resolution	0.1 m/s
	Accuracy	±0.2 m/s or ± 2 % RMS of reading, whichever is greater
	Start-up threshold	0.1 m/s
	Measuring rate	60 partial measurements/ 15 measurements per second
	Measurement output rate	1-10 seconds adjustable – default 10 s
Virtual temperature	Principle	Ultrasonic
	Measuring range	-50 ... +70 °C
	Resolution	0.1 °K
	Accuracy	± 2.0 K (without heater and without sun exposure or wind > 4m/s)
	Measuring rate	60 partial measurements/ 15 measurements per second
Air pressure	Principle	MEMS Capacitive
	Measuring range	300 ... 1200 hPa
	Accuracy	±1.5 hPa
Data output digital	Interface	RS485 semi-/full duplex, isolated
	Baudrate	1200-57600
	Meas. rate instant. value	1-10 s
	Measuring rate Avg (arithmetic, vector)	1-10 min
	Status	Heating, sensor failure
Data output analog	Only semi-duplex mode	
	Output signal	0 ... 20 mA, 4 ... 20 mA, 0 ... 10V, 2 ... 10V, 2 ... 2,000 Hz only output 1 (instantaneous, avg, min, max)
	Load	max. 500 Ohm
	Resolution	16 Bit
	Auflösung	16 Bit
General Information	Operating temperature	-40 ... +60 °C (with heating) -20 ... +60 °C (without heating)
	Bus operation	Up to 32 devices
	Operating voltage electronics	24 VDC ±10 % or 24 VDC/1.2 VA without heating 12 VDC
	with heating	24 VDC, max. 240 VA (140 W + 100 W)
	Connection	8-pole plug
	Housing material	Aluminum, seawater-proof
	Protection	IP66
	Pole diameter	50 mm/2"
	Factory certificate	yes
	Accessories	Surge protection
Power supply 24V/10A		8366.USV2
UMB Interface converter ISOCON-UMB		8160.UISO
Connection cable, 15 m incl. connector		8371.UK015
Connection cable, 50 m incl. connector		8371.UK050
Connector		8371.UST1

The operation of a wind power plant is not possible without reliable wind-related information. Environmental influences – strong winds, icing, reduced visibility control actions that must be optimized immediately. Lufft has the right “meteorological” product range for such an application, with its broad range of intelligent sensors with long-term stability.



Maintenance-free

Measuring



Lufft V200A-UMB – Ultrasonic Wind Sensor

Plastic Housing, 20 W-Heater



Extremely precise and maintenance-free measurement of wind velocity and wind direction as well as calculation of acoustic virtual temperature.

Belongs to Lufft's WS family of professional intelligent sensors with digital and analog interfaces.

The ultrasonic wind sensor is designed without mechanical parts – traditionally known as "cups and vane".

The digital or analog output delivers instantaneous, average, min or max value with flexible measuring rate. The V200A is heated to remove frost and ice formation from the sensor.

Recommended for:

- Meteorology
- Building automation

The following outputs/protocols are available:

- NMEA
- UMB-ASCII
- UMB-Binary
- MODBUS (ASCII, RTU)
- SDI-12
- 4 ... 20 mA, 0...10V, 0...20mA, 2...10V frequency (analog)

Lufft V200A-UMB Ultrasonic Wind Sensor			Order No.
V200A-UMB			8371.UA01
Technical Data	Dimensions	Ø approx. 150 mm, height approx. 170 mm	
	Weight	approx. 0.8 kg	
Wind direction	Principle	Ultrasonic	
	Measuring range	0 ... 359.9°	
	Resolution	0.1° (standard)	
	Accuracy	< 3° RMSE >1.0 m/s	
	Start-up Threshold	0.3 m/s	
	Measuring rate	60 partial measurements/ 15 measurements per second	
	Measurement output rate	1-10 seconds adjustable – default 10 s	
Wind speed	Principle	Ultrasonic	
	Measuring range	0 ... 75 m/s	
	Resolution	0.1 m/s	
	Accuracy	±0.3 m/s or 3% (0 ... 35 m/s) RMS of reading, whichever is greater ±5% (>35 m/s) RMS	
	Start-up threshold	0.3 m/s	
	Measuring rate	60 partial measurements/ 15 measurements per second	
	Measurement output rate	1-10 seconds adjustable – default 10 s	
Virtual temperature	Principle	Ultrasonic	
	Measuring range	-50° C ... +70° C	
	Resolution	0.1° K	
	Accuracy	± 2.0 K (without heater and without sun exposure or wind >4ms)	
Air pressure	Principle	MEMS Capacitive	
	Measuring range	300 ... 1200 hPa	
	Accuracy	+/- 0.5h Pa (0...+40°C)	
	Measurement output rate	1-10 seconds adjustable – default 10 s	
Data output digital	Interface	RS485 semi-/full duplex, isolated	
	Baudrate	1200-57600	
	Meas. rate instant. value	1-10 s	
	Measuring rate Avg (arithmetic, vector), Min, Max	1-10 min	
	Status	Heating, sensor failure	
Data output analog	Only semi-duplex mode		
	Output signal	0 ... 20 mA, 4 ... 20 mA, 0 ... 10V, 2 ... 10V, 2 ... 2,000 Hz only output 1 (instantaneous, avg, min, max)	
	Load	max. 500 Ohm	
	Resolution	16 Bit	
General Information	Operating temperature	-40 ... +60° C (with heating)	
	Bus operation	Up to 32 devices	
	Operating voltage electronics	24 VDC ±10% or 24 VDC/1,2 VA without heating: 12 VDC	
	with heating	24 VDC, max. 20 VA	
	Connection	8-pole plug	
	Housing material	Plastic	
	Protection	IP66	
	Pole diameter	50 mm/2"	
	Factory certificate	yes	
Accessories	Surge protection		8379.USP-V
	Power supply 24V/4A		8366.USV1
	UMB Interface converter ISOCON-UMB		8160.UISO
	Connection cable, 15 m incl. connector		8371.UK015
	Connection cable, 50 m incl. connector		8371.UK050
	Connector		8371.UST1



WS501-UMB with integrated pyranometer



WS301-UMB with integrated pyranometer



NIRS31 non-invasive road condition and road surface temperature sensor



Sensors

of the Highest Quality

It is difficult to believe that rain density can be measured, that a sensor can record the speed of precipitation and the size of the rain drops. In such cases, high-tech sensors can be extremely precise and meticulous in detail. When it is a matter of traffic safety, then Lufft Measuring Technology knows no excuses!

Lufft R2S-UMB – Precipitation Sensor (Present Weather Detector)

The drop speed is captured with a 24-GHz-Doppler radar.

The precipitation quantity and intensity is calculated from the correlation between drop size and speed.

The type of precipitation (rain, snow, sleet, freezing rain, hail) is detected from the difference in drop speed.

The measurement data is available for further processing in the form of a standard protocol (Lufft UMB protocol).

Lufft R2S-UMB Precipitation Sensor			Order No.
R2S-UMB EU, USA, Canada			8367.U01
R2S-UMB UK			8367.U02
Technical Data	Resolution liquid precipitation	0.01 ... 0.1 ... 1.0 mm/m ²	
	Power supply	20 ... 28 VDC	
	Power consumption without heating	2 VA	
	Heating power	30 VA	
	Op. temperature range	-40...+60°C	
	Op. humidity range	0 ... 100 %	
	Protection	IP67	
	Interface	RS485 semiduplex wire, UMB protocol, pulse and frequency interface	
	Cable length	10 m	
	Measuring range hail	5.1 ... approx. 30 mm	
Type of precipitation	Rain, snow, sleet, freezing rain, hail		
Precipitation	Principle	Doppler-Radar	
	Reproducibility	typ. > 90 %	
	Measuring range drop size	0.3 ... 5 mm	
Accessories	UMB Interface converter ISOCON-UMB		8160.UISO
	Power supply 24 V/4 A		8366.USV1
	Protection shield for R2S-UMB		8367.SCHIRM
	Traverse for R2S-UMB + WS500-UMB		8367.TRAV
	Surge protection		8379.USP
	Digital-analog-converter DACON8-UMB		8160.UDAC
	Connection cable, 20m		8370.UKAB20

Maintenance-free
Fast response time
Present weather detector
Resolution 0.01 mm



Lufft IRS31-UMB – Intelligent Road Sensor

Passive road sensor IRS31-UMB is flush-mounted in the road. The two part housing design allows the combined sensor/electronics unit to be removed for maintenance or calibration at any time.

The following variables are recorded:

- Road surface temperature
- Water film height up to 4 mm
- Freezing temperature for different de-icing materials
- Road condition (dry/damp/wet/ice or snow/residual salt/freezing rain)

Optional:

- 2 additional depth temperatures, e.g. at 5 cm and 30 cm

The sensors are addressable and can be networked.

The measurement data is available for further processing in the form of a standard protocol (Lufft UMB protocol).

Lufft IRS31-UMB Intelligent Road Sensor		Order No.
IRS31-UMB 50 m cable length		8510.U050
IRS31-UMB 100 m cable length		8510.U100
IRS31-UMB 50 m cable length, 2 depth temperature sensors		8510.U052
IRS31-UMB 100 m cable length, 2 depth temperature sensors		8510.U102
Technical Data	Dimensions	Ø 120 mm, height 50 mm
	Weight	approx. 800 g
	Detectable road conditions	Dry/damp/wet/ice or snow/residual salt content/freezing wetness
	Storage temperature	-40 ... 70 °C
	Rated current	< 200 mA
	Interface	RS485, Baudrate: 2400 ... 38400 bit/s (Standard: 19200)
	Protection	IP68
	Op. power consumption	9 ... 14 VDC, typical 12 V
	Plug	Cable 0.5 mm ²
	Op. temperature range	-40 ... 70 °C
	Operating humidity range	0 ... 100 % RH
	Road dampness	Unit: dry/damp/wet
	Slippery road conditions	Unit: no ice/snow, snow, freezing rain, ice
Road surface temp./below-ground temp.	Principle	NTC
	Measuring range	-40 ... 70 °C
	Accuracy	±0.2 °C (-10 ... 10 °C), otherwise ±0.5 °C
	Resolution	0.1
Freezing point	Measuring range	-20 ... 0 °C
	Accuracy	±1 °C for t > -10 °C
	Resolution	0.1
Water film height	Principle	Radar
	Measuring range	0 ... 4 mm
	Accuracy	±(0.1 mm + 20 % of measurement)
	Resolution	0.01 mm
Accessories	UMB Interface converter ISOCON-UMB	8160.UISO
	Spare part cap IRS31-UMB	8510.DEC
	Surge protection	8379.USP
	Digital-analog-converter DACON8-UMB	8160.UDAC



Order No. 8510.DEC

- Replaceable sensor electronics
- Polling via RS485 interface
- Low energy consumption (solar operation)
- Radar principle to measure water film



ARS31-UMB – Intelligent Road Sensor

The active ARS31-UMB sensor is flush-mounted in the the road/runway surface and calculates the freezing temperature by means of active cooling and heating of the sensor surface.

The freezing temperature measurement is independent of mixture.

The two-section housing design allows the combined sensor/electronics unit to be removed for maintenance purposes at any time, in just a few minutes.

In conjunction with the interface converter 8160.UISO, the sensor can be built into new and existing UMB networks.

Passive sensor IRS31-UMB and active sensor ARS31-UMB can be combined without difficulty.

The sensors are addressable and can be networked.

Lufft ARS31-UMB Intelligent Road Sensor		Order No.
ARS31-UMB 50m cable length		8610.U050
Technical Data	Dimensions	Ø 120 mm, height 50 mm
	Weight	approx. 900 g
	Storage temperature	-40 ... 70 °C
	Protection type	IP68
	Op. power consumption	9 ... 36 VDC
	Plug	CAGE CLAMP, WAGO (cross-section < 0.5 mm ²)
	Op. temperature range	-40 ... 70 °C
	Operating humidity range	0 ... 100 % RH
	Power consumption	approx. 30 W
	Interface	RS485, baud rate: 2,400 ... 38,400 bit/s (default: 19,200)
Freezing point	Measuring range	-20 ... 0 °C
	Accuracy	±0.5 °C RMS for Tg > -15 °C, or ±1.5 °C RMS for Tg < -15 °C (at NaCl)
	Resolution	0.1
Accessories	UMB Interface converter ISOCON-UMB	8160.UISO
	Spare part cap ARS31-UMB	8610.DEC
	Surge protector	8379.USP
	Digital-analog-converter DACON8-UMB	8160.UDAC



Order No. 8610.DEC

Replaceable sensor/electronics
Mixture-independent measurement



Lufft ARS31Pro-UMB – Intelligent Active Road Sensor

The active ARS31Pro-UMB sensor is flush-mounted in the road/runway surface and measures the freezing temperature by means of active cooling and heating of the sensor surface.

In addition, the ARS31Pro-UMB measures dry/wet-conditions and the road surface temperature; this surface temperature sensor is integrated into a second housing which is connected with the ARS31Pro-UMB.

The distance between the two housings is 50 cm.

One additional measurement is carried out in order to find out critical conditions in the next few hours. This early alert message is an extra road surface condition information in addition to the road conditions which are measured „now“.

The freezing temperature measurement is independent of mixture. The two-section housing design allows the combined sensor/electronics unit to be removed for maintenance purposes at any time, in just a few minutes.

In conjunction with the interface converter 8160.UISO, the sensor can be built into new and existing UMB networks.

The sensors are addressable and can be networked.

Lufft ARS31Pro-UMB Intelligent Road Sensor			Order No.
ARS31Pro-UMB 50m cable length			8810.U051
Technical Data	Dimensions	Ø 120 mm, height 50 mm	
	Weight	approx. 1100 g	
	Detectable road conditions	Dry/wet/critical wetness/ice alert	
	Storage temperature	-40 ... 70 °C	
	Protection type	IP68	
	Op. power consumption	9 ... 36VDC	
	Plug	CAGE CLAMP, WAGO (cross-section < 0.5 mm ²)	
	Op. temperature range	-40 ... 70 °C	
	Operating humidity range	0 ... 100 % RH	
	Power consumption	approx. 30 W	
	Interface	RS485, baud rate: 2,400 ... 38,400 bit/s (default: 19,200)	
Freezing point	Measuring range	-20 ... 0 °C	
	Accuracy	±0.5 °C RMS for Tg > -15 °C, or ±1.5 °C RMS for Tg < -15 °C (at NaCl)	
External Road surface temp	Principle	NTC	
	Measuring range	-40 ... 70 °C	
	Accuracy	±0.2 °C (-10 ... 10 °C), or ±0.5 °C	
	Resolution	0.1	
Accessories	UMB Interface converter ISOCON-UMB		8160.UISO
	Spare part cap + electronics ARS31Pro-UMB		8610.DEC
	Surge protector		8379.USP
	Digital-analog-converter DACON8-UMB		8160.UDAC



External Road surface temp. Sensor

Replaceable sensor/electronics

Simulation of critical surface conditions in the very near future

All-in-one sensor including active measurement of freeze point temperature

Mixture-independent measurement

Analog outputs in combination with 8160.UDAC



Passive Road Surface Temperature Sensor

The surface temperature sensor measures runway and highway-temperatures highly precise, both on asphalt and concrete.
Works also in conjunction with ARS31pro.

Passive Road Surface Temperature Sensor			Order No.
WST1 50 m cable length			8160.WST1
Technical Data	Dimensions	Ø 60 mm, height 40 mm	
	Weight	approx. 150 g	
	Storage temperature	-40 ... 70 °C	
	Protection type	IP68	
	Op. temperature range	-40 ... 70 °C	
Temperature/NTC	Measuring range	-40 ... +70 °C	
	Accuracy	±0.3 °C (-10...+10°C) otherwise ±1.0 °C	

Passive Road Surface Temperature Sensor			Order No.
WST2 50 m cable length			8160.WST2
Technical Data	Dimensions	Ø 60 mm, height 40 mm	
	Weight	approx. 150 g	
	Storage temperature	-40 ... 70 °C	
	Protection type	IP68	
	Op. temperature range	-40 ... 70 °C	
Temperature/PT100	Measuring range	-40 ... +70 °C	
1/3 DIN B	Accuracy	±0.1 °C at 0°C	
Zubehör	UMB Interface converter ANACON-UMB		8160.UANA

The runway/road surface temperature sensor 8160.WST1 can be connected with any WS family sensor of Lufft UMB technology.

The runway/road surface temperature sensor 8160.WST2 can be used with Lufft UMB-ANACON converter.





Non-invasive

Measurements ...

*... deliver freezing point temperature, is this really possible?
Yes, because automatic freeze-free systems need this input;
Yes, because on-time winter treatment actions are based on
this information;
Yes, because variable message signs can display ice risks
automatically.*



Lufft NIRS31-UMB – Non Invasive Measurements Using Optical Principle

Lufft road sensors use optical measuring principles. Without a need to install the embedded sensors, these non-intrusive multi-sensor-systems have integrated microprocessors to identify all road and runway conditions.

The measurement principle (optical / spectroscopical): Water absorbs certain wave lengths differently. If there is a water layer on a runway or a highway, then the spectral characteristics are changed.

Measurement of surface conditions such as wet ice, snow, or frost.

Dependent on the requirements of any traffic-related weather network, there is a need for embedded and/or non-invasive/non-intrusive sensing equipment. Luffts NIRS31-UMB adds to Luffts series of pavement sensors: an intelligent sensor which is part of the pole or part of bridge surpassing the motorway. Mainly on bridges, which do not allow in all cases embedded sensors, the NIRS31-UMB is an alternative to Luffts IRS31-UMB. Microclimates that need frequent asphalt reconstruction prefer non-invasive technology as well to reduce the maintenance costs.

The typical distance between the surface measurement spot and the sensor is 6 ...15 meters. In addition to the well-known measurements in winter-related road networks

- waterfilm
- surface temperature
- freeze point temperature

the sensor delivers the new information "friction". Whenever the quantity of ice particles increase on the measured spot, the friction reading will be changed and herewith can be used for on-time treatments. Non-invasive sensors cannot measure depth temperature(s).

Measurement output can be accessed by the following protocols:
UMB-Binary, SDI-12

UMB-Config-Tool Software for:

- Configuration of sensors
- Onsite calibration
- Real-time date of sensor
- Firmware-Update for UMB sensors
- Analogue outputs in combination with 8160.UDAC

Lufft NIRS31-UMB Non Invasive Sensor			Order No.
<ul style="list-style-type: none"> - Measurement of surface conditions such as wetness, ice, snow, or frost. - Measurement of water film height - Measurement of ice percentage in water and determination of freeze temperature - Measurement of friction - Fully integrated surface temperature measurement (pyrometer) as option - Electric Isolation of RS485 interface for network with other UMB sensors - Easy to mount - Firmware-Updates via UMB-technology 			8710.U01
Technical Data	Dimensions	H. ca. 425mm, W. ca. 225mm, D. ca. 285mm	8710.UT01
	Weight	10kg	
Storage conditions	Ambient air temperature	-40°C ... +70°C	
	Ambient rel. humidity:	< 95% RH, non condensing	
Operating conditions	Operating voltage	24VDC +/- 10% (22 – 30VDC)	
	Power consumption	approx. 40VA	
	Temperature	-40°C...+60°C	
	Protection type	IP65	
Layer thickness	Water, Snow, Ice		
	Principle	Optical	
	Measurement range	0...2mm (snow 0 ... 10 mm)	
	Resolution	0.01 mm	
Surface temperature (optional)	Principle	Pyrometer	
	Measurement range	-40 ... +70 °C	
	Accuracy	±0.8°C	
	Resolution	0.1 °C	
Surface conditions Friction	Dry, Damp, Wet, Snow, Ice		
	Measurement range 0 ... 1 (critical ... dry)		
Accessories	Surge protection		8379.USP
	Power supply 24V/4A		8366.USV1
	UMB Interface converter ISOCON-UMB		8160.UISO
	Digital-analog-converter DACON8-UMB		8160.UDAC
	Connection cable, 15 m incl. connector		8371.UK015
	Connection cable, 50 m incl. connector		8371.UK050





Artificial Eye on Site

*Years ago decision makers for winter treatments had to check roads in the middle of the night;
later they accessed measurements in their computer centers;
today we deliver a high-resolution color picture and real-time measurements
wherever they are ...*

Lufft Night Vision Camera

High Resolution Color Pictures

Camera = "Virtual eye on site" in conjunction with measurement data.

Images of road condition day and night in real time with infrared spotlight (option) and GPRS transmission. Creates trust and visually illustrates measurement data. Recommended especially in conjunction with ice warning systems to limit patrols to the greatest possible extent.

Lufft Night Vision Camera		Order No.
Night Vision Camera , high resolution, 3 Mega pixel		9983.10
Night Vision Camera , VGA resolution		9983.20
Technical Data	Indoor/Outdoor	Dual lens outdoor, weather-proof (IP65), -30 ... +60 °C
	Lenses	Wide Angle (43mm, F 2.0)
	Resolution	VGA (1024x768 pixels each), color + B/W
	Sensitivity Color	1 lux (t=1/60s) 0.05 lux (t=1/1s)
	Interfaces	Ethernet 10/100 Mbps, RS232
	Power Supply	PoE or MX30V
Accessories	Infrared spotlight LED	9984.00
	Surge protection	8379.USP-RJ45





Quality

For Long-Term Visibility

In fog, a visibility of more than 500 meters is not a problem as an impact on traffic is not expected. However, extremely precise measurements have to be taken within the low measurement ranges. The level of danger is at its highest when visibility drops below 50 metres, which is why in such cases speed limits of 40-60 km/h are displayed on dynamic or variable message signs. Nevertheless, traffic limitations are imposed as soon as visibility drops to 250 metres. Fog is precisely detected within a range of 10 to 2,000 metres with the visibility sensor VS20.

Lufft VS20-UMB – Visibility Sensor

- Measures visibility up to 2000 m / 3000 m
- Ideal for road traffic applications
- Analog output 4...20 mA
- Digital UMB protocol (RS485 interface)
- Calibration device available (optional)

The VS20 is configured via the software UMB Config Tool:

- Reading / Changing of the current configuration
- Calibration
- Polling of the current measurement values
- The software allows configurations to be loaded and stored

The measurement data is available for further processing in the form of a standard protocol (Lufft UMB protocol).

Lufft VS20-UMB Visibility Sensor		Order No.
VS20-UMB	Measuring range 10 ... 2000 m	8366.U50
VS20-UMB	Measuring range 10 ... 3000 m	8366.U60
Technical Data	Output signal	4 ... 20 mA / 20 ... 4 mA
	Interface	RS485 semi-duplex wire, UMB protocol
	Protection	IP66
	Weight	approx. 4 kg
	Dimensions	360 x 180 x 80 mm
	Op. temperature range	-40 ... 60 °C
	Power supply	typ. 24 VDC (22 ... 28 VDC) 3 W
	Included in delivery	Connection cable
	Value update	1 minute
Visibility	Cable length	10 m
	Principle	Forward scattered light procedure
	Unit	m
Accessories	Accuracy	±10 m or ±10 %, highest value applies
	UMB Interface converter ISOCON-UMB	8160.UISO
	Connecting cable	8366.UKAB10
	Calibration kit visibility	8366.UKAL1
	Power supply 24 V/4 A	8366.USV1
	Surge protection	8379.USP



10 ... 2000 m measurement range
 Calibration kit (optional)
 Forward light scattering technique

Temperature, Humidity, Snow Height

Lufft Temperature Probe			Order No.
Temperature Probe			8160.WST1
Temperature	Principle	NTC	
	Measuring range	-40 ... +70 °C	

Lufft Temperature Probe			Order No.
Temperature Probe			8160.WST2
Temperature	Principle	PT100 1/3 DIN B	
	Measuring range	-40 ... +70 °C	
Accessoires	UMB Interface converter ANACON-UMB		8160.UANA

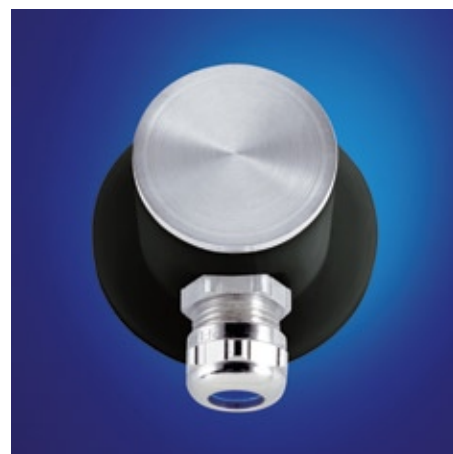

Lufft Temperature probe			Order No.
Temperature probe			8160.TF
Technical Data	Dimensions	Length 50 mm, Ø 6 mm	
	Output signal	Resistance	
	Dimensions	370 g	
	Cable length	10 m	
	Protection	IP68	
	Plug	COMBICON Phoenix, gold contacts	
	Op. temperature range	-50 ... 150 °C	
	Operating humidity range	0 ... 100 % RH	
	Temperature	Principle	PT100
	Measuring range	-50 ... 150 °C	

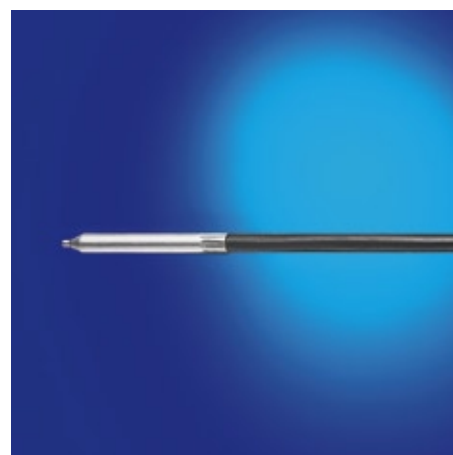

Lufft Temperature/relative humidity probe			Order No.
Temperature/relative humidity probe 10 m cable length			8160.TFF10
Temperature/relative humidity probe 50 m cable length			8160.TFF50
Technical Data	Dimensions	Length 185 mm, Ø 16 mm	
	Output signal	Resistance, frequency	
	Operating voltage	6 ... 15 V	
	Operating current	approx. 10 mA	
	Weight	400 g	
	Protection	IP54	
	Plug	COMBICON Phoenix	
	Op. temperature range	-30 ... 70 °C	
	Operating humidity range	0 ... 100 % RH	
Relative humidity	Principle	Capacitive	
	Measuring range	0 ... 100 % RH	
	Accuracy	±2 % RH	
Temperature	Principle	PT1000	
	Measuring range	-30 ... 70 °C	
	Accuracy	±0.2 °C	
Accessories	Measuring head for 8160.TFF10 and 8160.TFF50		8160.HC
	Radiation shield		8150.SCHUW

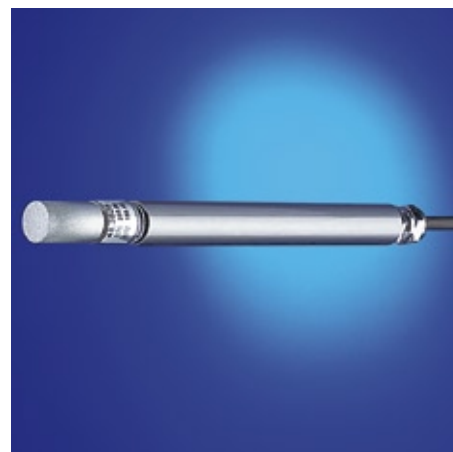

Wind (Ultrasonic)

Lufft VENTUS-UMB Wind Sensor with factory certificate			Order No.
VENTUS-UMB			8371.UM
VENTUS-UMB for wind energy applications			8371.UMT
Technical Data	Dimensions	Ø approx. 150 mm, height app. 170 mm	
	Weight	approx. 1.7 kg	
Wind direction	Principle	Ultrasonic	
	Measuring range	0 ... 359.9°	
	Accuracy	± 2° RMSE > 1.0 m/s	
Wind speed	Principle	Ultrasonic	
	Measuring range	0 ... 75 m/s	
	Accuracy (0...65m/s)	± 0.2 m/s or ± 2 % RMS, whichever is greater	
Virtual Temperature	Principle	Ultrasonic	
	Measuring range	-50 ... +70 °C	
	Resolution	0.1 °K	
	Accuracy	± 2.0° (without heater and without sun exposure or wind > 4m/s)	
Air pressure	Principle	MEMS Capacitive	
	Measuring range	300 ... 1200 hPa	
	Accuracy	±1.5 hPa	
General Information	Operating temperature	-40 ... +60 °C (with heating) -20 ... +60 °C (without heating)	
	Bus operation	Up to 32 devices	
	Operating voltage electronics	24 VDC ±10 % or 24 VDC/1.2 VA 12 VDC without heating	
	with heating	24 VDC, max. 240 VA (140 W + 100 W)	
	Connection	8 pole Plug	
	Housing material	Aluminum, seawater-proof	
	Protection	IP 66	
	Pole diameter	50 mm/2"	

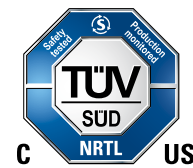

**Now UL-certified
Underwriters
Laboratories Inc.**

Accessories see page 23

Lufft V200A-UMB Ultrasonic Wind Sensor with factory certificate			Order No.
V200A-UMB			8371.UA01
Technical Data	Dimensions	Ø approx. 150 mm, height ap. 170 mm	
	Weight	approx. 0.8 kg	
Wind direction	Principle	Ultrasonic	
	Measuring range	0 ... 359.9°	
	Accuracy	< 3° RMSE > 1.0 m/s	
Wind speed	Principle	Ultrasonic	
	Measuring range	0 ... 75 m/s	
	Resolution	0.1 m/s	
	Accuracy (0...60m/s)	± 0.3 m/s or 3% (0 ... 35 m/s) RMS of reading, whichever is greater ±5% (> 35 m/s) RMS	
Virtual Temperature	Principle	Ultrasonic	
	Measuring range	-50 °C ... +70 °C	
	Resolution	0.1 °K	
	Accuracy	± 2.0° (without heater and without sun exposure)	
Air pressure	Principle	MEMS Capacitive	
	Measuring range	300 ... 1200 hPa	
	Accuracy	±1.5 hPa	
General Information	Operating temperature	-40 ... +60 °C (with heating) -20 ... +60 °C (without heating)	
	Bus operation	Up to 32 devices	
	Op. voltage electronics	24 VDC ±10 % or 24 VDC/1.2 VA 12 VDC without heating	
	with heating	24 VDC, max. 20 VA	
	Connection	8 pole Plug	
	Housing material	Plastic	
	Protection	IP66	
	Pole diameter	50 mm/2"	



Accessories see page 25

Precipitation (Tipping Bucket)

Lufft Rain Gauge		Order No.
Rain gauge 0.1 mm unheated		8353.13
Rain gauge 0.1 mm heated		8353.13H
Technical Data	Dimensions	Ø 190 mm, Height 292 mm
	Connection type	Open cable ends
	Collecting area	200 cm ²
	Resolution	0.1 mm (tipping bucket)
	Weight	approx. 4 kg
	Mounting type	On mast, Ø 60 mm
	Operating temp. range, rain gauge unheated	0 ... 70 °C
	Operating temp. range, rain gauge heated	-30 ... 70 °C
Heating	42 V/AC, 170 VA	
Accessories	Power supply for heated probe 8353.13H	8353.SV1
	Stand, height 1 m for 8353.13	8353.FUS2
	Stand, height 1 m for 8353.13H	8353.FUS3



Lufft Rain Gauge		Order No.
Rain gauge 0.1 mm unheated		8353.12
Rain gauge 0.1 mm heated		8353.12H
Technical Data	Dimensions	Ø 190 mm, height 292 mm
	Connection type	Open cable ends
	Collecting area	200 cm ²
	Resolution	0.1 mm (tipping bucket)
	Weight	approx. 3 kg
	Mounting type	On mast, Ø 60 mm
	Operating temp. range, rain gauge unheated	0 ... 70 °C
	Operating temp. range, rain gauge heated	-20 ... 70 °C
Heating	24 VDC 150 W	
Accessories	Power supply for heated probe 8353.12H	8366.USV2
	Stand, height 1 m for 8353.12	8353.FUS2
	Stand, height 1 m for 8353.12H	8353.FUS3



Lufft Rain Gauge		Order No.
Rain gauge 0.2 mm unheated		8353.04
Technical Data	Dimensions	Ø165 mm, height 255 mm
	Connection type	Open cable ends
	Collecting area	200 cm ²
	Resolution	0.2 mm (tipping bucket)
	Dimensions	380 g
Mounting type	On mast, Ø 50 mm	



Air Pressure, Wind

Lufft Air Pressure Sensor			Order No.
Air Pressure Sensor			8355.03
Technical Data	Dimensions	100 mm x 65 mm x 41 mm	
	Connection type	Cable clips	
	Output signal	4 ... 20 mA	
	Operating voltage	7 ... 15 VDC	
	Operating current	≤ 4 mA	
	Weight	approx. 360 g	
	Protection	IP54	
	Op. temperature range	-40 ... 60 °C	
	Max. burden	< (UB - 7 V) / 20 mA	
	Operating humidity range	0 ... 95 % RH (non-condensing)	
Absolute pressure	Principle	Capacitive ceramic	
	Measuring range	0 ... 1200 hPa	
	Accuracy	±1.5 hPa, for 0 °C < T < 40 °C and 600 hPa < Pabs < 1100 hPa	
Absolute pressure	Principle	Capacitive ceramic	
	Measuring range	0 ... 1200 hPa	
	Accuracy	±2.0 hPa, for -20 °C < T < 45 °C and 600 hPa < Pabs < 1100 hPa	
Absolute pressure	Principle	Capacitive ceramic	
	Measuring range	0 ... 1200 hPa	
	Accuracy	±3.0 hPa, for -40 °C < T < 60 °C and 600 hPa < Pabs < 1100 hPa	
Absolute pressure	Principle	Capacitive ceramic	
	Measuring range	0 ... 1200 hPa	
	Accuracy	±0.5 hPa, for T = 20 °C and 600 hPa < Pabs < 1100 hPa	



Lufft Wind sensor			Order No.	
Wind sensor unheated			8368.01	
Wind sensor heated			8368.02	
Technical Data	Dimensions	Traverse 1 m		
	Start-up value	0.9 m/s		
	Connection type	Open cable ends		
	Weight	2.5 kg		
	Cable length	10 m		
	Protection	IP65		
	Wind direction	2° open at south		
	Op. temperature range	-30 ... 70 °C		
	Wind speed	Principle/Measuring range	Generator/0.9 ... 50 m/s	
		Principle/Measuring range	Potentiometer/0 ... 358°	
Accessories	Power supply for heated sensors		8161.SV4	



Lufft Wind sensor			Order No.
Wind sensor unheated			8368.03
Wind sensor heated			8368.04
Technical Data	Dimensions	165x115mm	
	Start-up value	0.9 m/s	
	Connection type	Open cable ends	
	Weight	500 g	
	Cable length	10 m	
	Protection type wind sensor unheated	IP54	
	Protection type wind sensor heated	IP65	
	Op. temperature range	-30 ... 70 °C	
	Heating	20 W, 12 V/24 VDC	
	Wind speed	Principle	Generator
Measuring range		0.9 ... 50 m/s	
Accessories	Power supply for heated probes		8161.SV4



Pyranometer Radiation

Lufft CMP11 Pyranometer Radiation			Order No.	
CMP11			8346.CMP11	
Technical Data	ISO Classification	Secondary standard		
	Response time (95 %)	< 5 s		
	Zero offsets thermal radiation (200 W/m ²)	< 7 W/m ²		
	Zero offsets Temperature change (5 K/hr)	< 2 W/m ²		
	Non-stability (change/year)	< 0.5 %		
	Non-linearity (0 to 1,000 W/m ²)	< 0.2 %		
	Directional error (at 80 ° with 1,000 W/m ²)	< 10 W/m ²		
	Temperature dependence of sensitivity	< 1 % (-10 to +40 ° C)		
	Tilt error (at 1,000 W/m ²)	< 0.2 %		
	Sensitivity	7 to 14 µV/W/m ²		
	Impedance	10 to 100 Ohm		
	Level accuracy	0.1 °		
	Operating temperature	-40 to +80 ° C		
	Spectral range (50 % points)	285 to 2,800 nm		
	Typical signal output for atmospheric applications	0 to 15 mV		
	Maximum irradiance	4,000 W/m ²		
	Expected daily uncertainty	±2 %		
	Standard cable length	10 m		
	Radiation	Unit	W/m ²	
	Accessories	Transmitter 4...20 mA		8346.AMP
Mounting fixture for 8346.CMP6 und 8346.CMP11			8346.M02	



Lufft CMP3 Pyranometer Radiation			Order No.	
CMP3			8346.CMP3	
Technical Data	ISO Classification	Second Class		
	Response Time (95 %)	< 18 s		
	Zero offsets thermal radiation (200 W/m ²)	< 15 W/m ²		
	Zero offsets Temperature change (5 K/hr)	< 5 W/m ²		
	Non-stability (change/year)	< 1 %		
	Non-linearity (0 to 1,000 W/m ²)	< 1 %		
	Directional error (at 80 ° with 1,000 W/m ²)	< 20 W/m ²		
	Temperature dependence of sensitivity	< 5 % (-10 to +40 ° C)		
	Tilt error (at 1,000 W/m ²)	< 1 %		
	Sensitivity	5 to 20 µV/W/m ²		
	Impedance	20 to 200 Ohm		
	Level accuracy	1 °		
	Operating temperature	-40 to +80 ° C		
	Spectral range (50 % points)	300 to 2,800 nm		
	Typical signal output for atmospheric applications	0 to 20 mV		
	Maximum irradiance	2,000 W/m ²		
	Expected daily uncertainty	±10 %		
	Standard cable length	10 m		
	Radiation	Unit	W/m ²	
	Accessories	Transmitter 4...20 mA		8346.AMP
Mounting fixture for 8346.CMP3 und 8346.SPLITE2			8346.M01	



Lufft CMP6 Pyranometer Radiation			Order No.	
CMP6			8346.CMP6	
Technical Data	ISO Classification	First Class		
	Response time (95 %)	< 18 s		
	Zero offsets thermal radiation (200 W/m ²)	< 12 W/m ²		
	Zero offsets Temperature change (5 K/hr)	<4 W/m ²		
	Non-stability (change/year)	< 1 %		
	Non-linearity (0 to 1,000 W/m ²)	< 1 %		
	Directional error (at 80 ° with 1,000 W/m ²)	< 20 W/m ²		
	Temperature dependence of sensitivity	< 4 % (-10 to +40 °C)		
	Tilt error (at 1,000 W/m ²)	< 1 %		
	Sensitivity	5 to 20 μV/W/m ²		
	Impedance	20 to 200 Ohm		
	Level accuracy	0.1 °		
	Operating temperature	-40 to +80 °C		
	Spectral range (50 % points)	285 to 2800 nm		
	Typical signal output for atmospheric applications	0 to 20 mV		
	Maximum irradiance	2,000 W/m ²		
	Expected daily uncertainty	±5 %		
	Standard cable length	10 m		
	Radiation	Unit	W/m ²	
	Accessories	Transmitter 4...20 mA		8346.AMP
Mounting fixture for 8346.CMP6 and 8346.CMP11			8346.M02	



Lufft SP LITE2 Silicon Pyranometer Radiation			Order No.	
SP LITE2			8346.SPLITE2	
Technical Data	Response time (95 %)	< 1 ms		
	Non-stability (change/year)	<2 %		
	Non-linearity (0 to 1,000 W/m ²)	<1 %		
	Directional error (at 80 ° with 1,000 W/m ²)	<50 W/m ²		
	Temperature dependence (-30 to +70 °C)	-0.15 %/°C		
	Sensitivity	60 to 100 μV/W/m ²		
	Operating temperature	-30 ... 70 °C		
	Spectral range (50 % points)	400 to 1,100 nm		
	Typical signal output for atmospheric applications	0 to 100 mV		
	Maximum irradiance	2,000 W/m ²		
	Standard cable length	5 m		
	Impedance	50 Ohm		
	Detector	Silicon photo-diode		
	Radiation	Unit	W/m ²	
	Accessories	Mounting rod for 8346.CMP3 and 8346.SPLITE2		8346.M01



Lufft UMB-Modules

Common features of all UMB modules

- Galvanic isolation between sensor supply and communication
- Host communication via RS232 (PC / GPRS-modem), RS485 (EAK)
- Small housing with top hat rail mounting and bus-connection
- Firmware update via RS232
- Common power supply (24V) for UMB modules and (heated) sensors
- Online data-transfer (no memory)
- Network with up to 32 modules

ISOCON-UMB communication module for all UMB sensors

- Communication-watchdog for reliable sensor function (reset)
- Overvoltage protection for all interfaces
- LED indication for operation mode

ANACON-UMB 2-channel universal transmitter

2 analog inputs, 24 bit resolution for voltage, current and resistance LED indication for operation mode for following Lufft-sensors:

- Temperature / humidity sensor
- Combined wind / air pressure sensor
- Ultrasonic wind sensor 4 ... 20 mA
- Precipitation gauge (tipping bucket)

Other inputs:

Digital signals (e.g. door contact)

IRS21CON-UMB communication module for Lufft road sensor IRS21

- Converts the IRS21 protocol into UMB protocol
- Controls the galvanic isolated power supply for IRS21
- Overvoltage protection for all interfaces
- LED indication for operation mode

Lufft UMB-Modules			Order No.
ISOCON-UMB			8160.UIISO
ANACON-UMB			8160.UANA
IRS21CON-UMB			8410.UIISO
Operating conditions	Power supply	12 ... 26VDC	
	Power consumption	< 100 mA	
	Ambient temperature	-30 °C ... +60 °C	
	Relative humidity	< 95 % RH	
	Protection	IP20	
	Module width	23 mm	
	RS232 Plug	DSUB9	
	Sensor connector	Screw type	
Storage conditions	Ambient temperature	-40 °C ... +70 °C	
	Relative humidity	< 95 % RH	
Accessories	Power supply 24V/4A		8366.USV1
	GPRS/GSM modem with camera connection		8160.MOD-VIOLA
	Night vision camera, 3 Mega pixel		9983.10
	Night vision camera, VGA		9983.20



- Compact design
- Easy commissioning
- RS232 or RS485 data transfer
- Easy software updates
- Free configuration software

Lufft DACON8-UMB = 8 Channel Digital-Analog Converter for all Lufft UMB Sensors

The Lufft-DACON8-UMB (Digital-Analog-Converter) converts up to 8 channels into analog output signals. The converter can be used with one or a combination of different UMB sensors.

The Lufft-DACON8-UMB uses the UMB protocol of the sensors to read the data and converts the digital data into voltage or current output.

In case of having only one Lufft UMB sensor, the combination of the sensor and DACON8-UMB works without any other interface inbetween.

If the Lufft DACON8-UMB has to convert data of more than one Lufft UMB sensor, then every UMB sensor needs a Lufft ISOCON between the sensor itself and the DACON8-UMB, and must be connected to the RS485-bus.

In case there are more than 8 channels requested by the application, the DACON8-UMB application can work with more than one converter. It is necessary to use one converter per DACON8-UMB.

Lufft DACON8-UMB (Digital/Analog converter)			Order No.
DACON8-UMB			8160.UDAC
Technical data	Current	0 or 4-20 mA	
	Voltage	0 or 2-10 V	
	Accuracy	max. 0.5% over the whole range	
	Maximum load	500 Ω	
	Resolution	16 bits	
	UMB Channels	adjustable	
	Max channels	8	
	Update rate	1-10 seconds	
	Only one DACON8-UMB per bus		

Example 1: One DACON8-UMB / one UMB-sensor. recommended: overvoltage protection 8379.USP



Example 2: One DACON8-UMB / three UMB-sensors and 3 ISOCONs. recommended: overvoltage protection 8379.USP

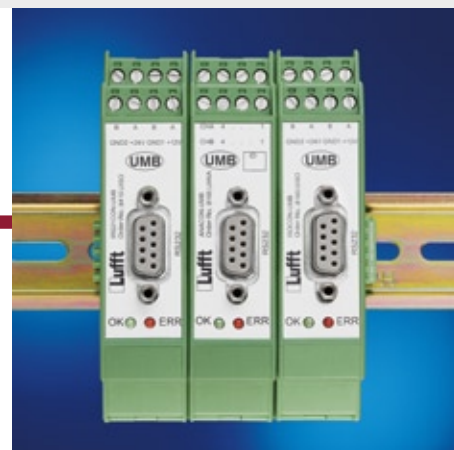

- Compact design
- Easy commissioning
- Easy software updates
- Free configuration software

LCOM – Luft-Communicator / Datalogger

The LCOM (Luft-Communicator) is an industrial PC with the Windows-CE operating system. The following interfaces are available for communication purposes:

- USB
- CDMA modem (RS232)
- Partyline modem (RS232)
- UMB bus (RS485)
- TCP/IP (Ethernet)

Conversion to the following standard protocols can be made in combination with the UMB technology:

- TLS
- NTCIP
- TLS over IP with GPRS (Asfinag)
- MSSI (Asfinag)
- Synop (in planning)

The equipment is configured and measurement data presented on the built-in 7 inch touch screen display. A service PC is no longer required.

Remote access is available for software uploads and data analysis on the LCOM and UMB modules over the GPRS modem.

The LCOM has an integrated SD card to store measurements.

LCOM Luft Communicator			Order No.
LCOM			8510.EAK
Operating Conditions	Power supply	20...28VDC	
	Power consumption	10VA	
	Ambient temperature	-30 °C... +60 °C	
	Relative humidity	< 90 % RH	
	Protection	IP20	
	Dimensions	230 mm x 130 mm x 50 mm	
	USB Interface	USB2.0B	
	GPRS modem interface	RS232 on Wago Cage Clamp	
	Party line modem interface	RS232 on Wago Cage Clamp	
	UMB bus interface	RS485 on Wago Cage Clamp	
Storage conditions	Display size	7 inch	
	Display resolution	800 x 480 pixel	
	Ambient temperature	-30 °C... +60 °C	
Accessories	Relative humidity	< 95 % RH	
	Power supply 24V/4A		8366.USV1
	GPRS Modem		8510.GPRS
	Night vision camera, 3 Mega pixel		9983.10
	Night vision camera, VGA		9983.20



Modem

Mobile GSM router		Order No.
Mobile GSM router		8160.MOD-INSYS
Modem for UMB and camera, "dual use"		
RWIS applications with high-resolution pictures (jpg) need a modem including an integrated industrial Ethernet switch. A lean hardware solution together with the Lufft LCOM 8510.EAK. The modem requires less space in the enclosure. It is very easy to configure the device. The modem supports not only GPRS, but UMTS in addition. Made for DIN-rail-mounting.		
Optional	Modem without Ethernet switch	8160.MOD-VIOLA



GPRS Modem	Order No.
GPRS Modem	8510.GPRS



Fold-Over mast, hot-dip galvanized		Order No.
Fold-Over mast		8357.450
Technical Data	Dimensions Length 450cm	
Accessories	Metal box, small, for 8357.450 Dimensions 120 mm height x 360 mm wide x 80 mm deep	8357.CAS1
	Cabinet, large Dimensions 600 mm height x 400 mm wide x 210 mm deep	8357.CAS2
	Cabinet UMB, for Lufft pole 8357.450 8357.CAS3 (incl. mounting rails, wiring channel, plug socket, connecting terminal, protective switch, bag for connection diagram) Dimensions 600 mm high x 400 mm wide x 210 mm deep	8357.CAS3
	Cabinet UMB for other poles (incl. mounting rails, wiring channel, plug socket, connecting terminal, protective switch, bag for connection diagram) Dimensions 600 mm high x 400 mm wide x 210 mm deep	8160.CAS4
	Lockable tilt device	8357.450V
	4 fixed anchor dowel pins	8357.450D
	Switch for door contact	8160.UDC
	Fault current protective switch	8160.UFI
	Arresting cable	8357.450UAC
	Cables between sensors and weather case are "non-visible"	



UMB Configuration Examples

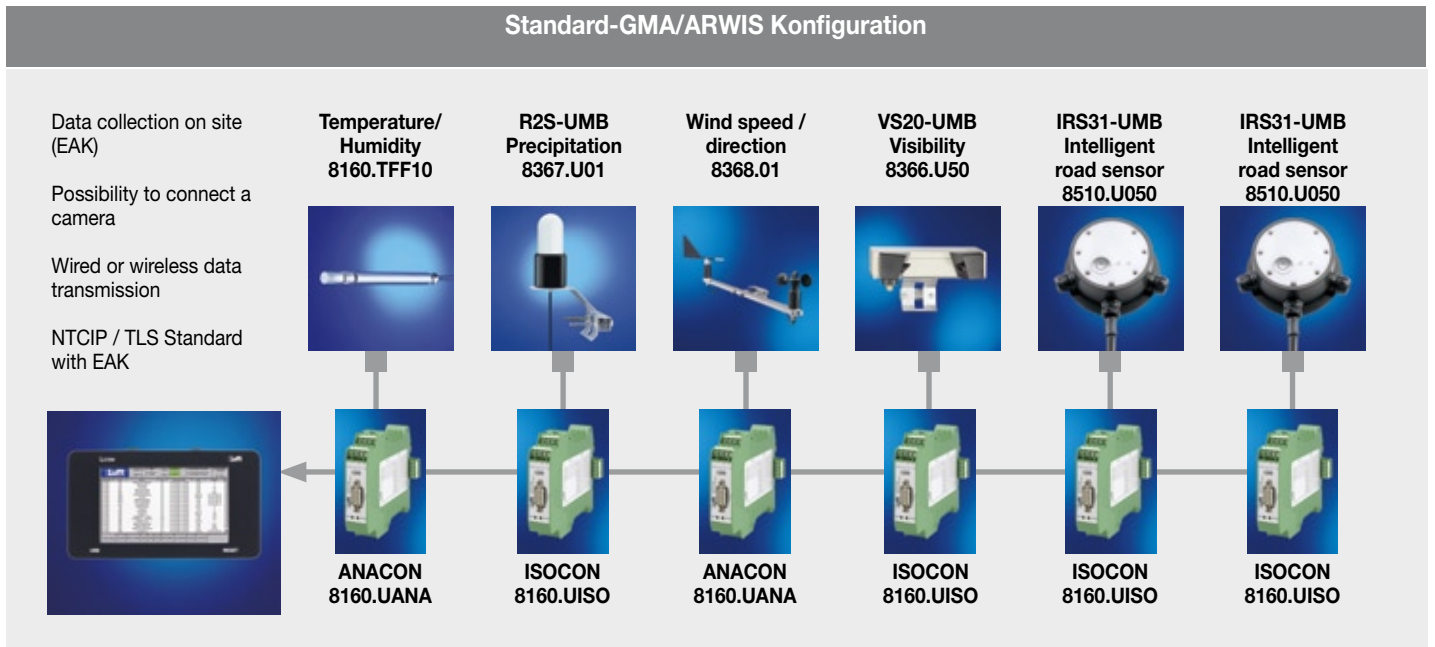
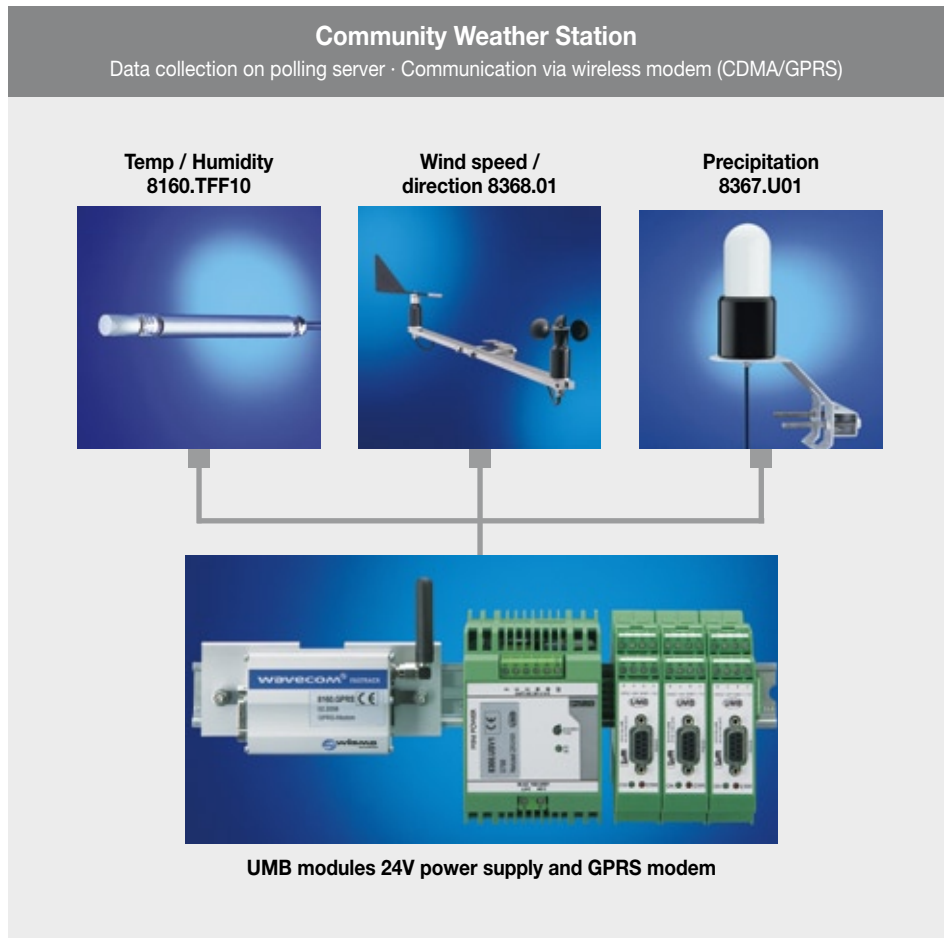

Lufft UMB Configuration Software

Functions

- Configuration of sensors
- On-site calibration of sensors
- Indication of current measurement values
- Firmware update for UMB-sensors and UMB-modules
- Multi-lingual user interface
- TCP/IP

Configuration of analog sensors

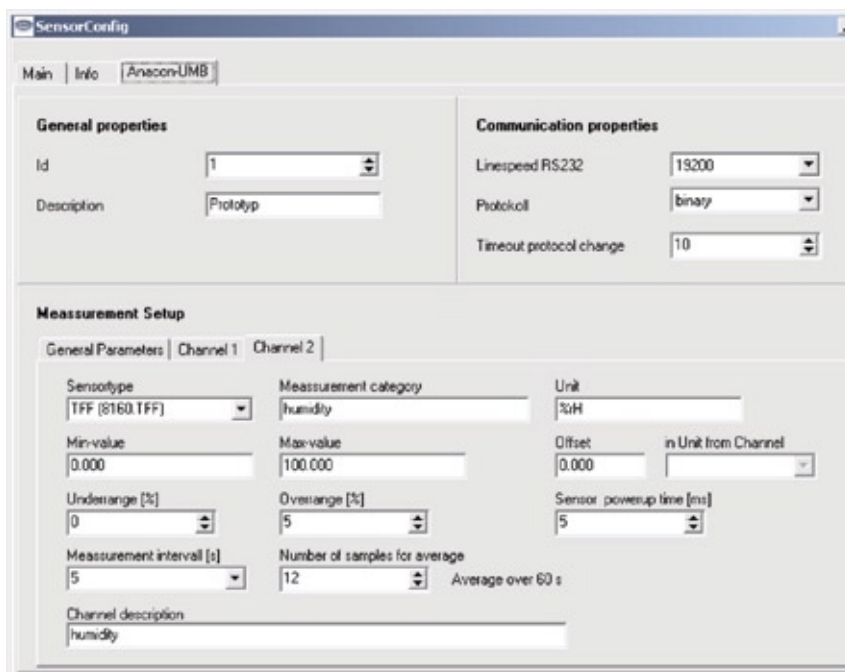

Selection list of sensors

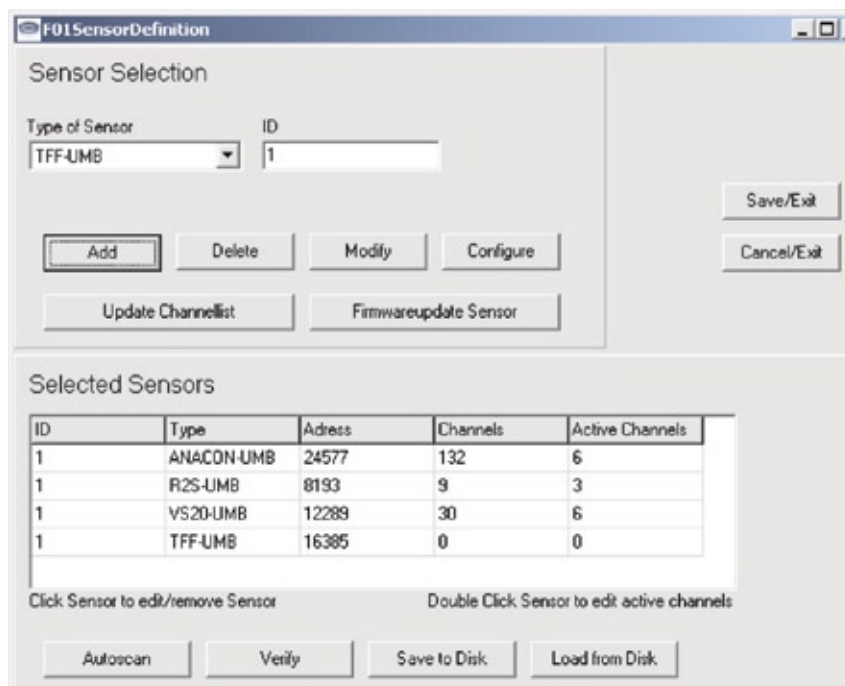

Selection list of sensor channels
(temporary data request)

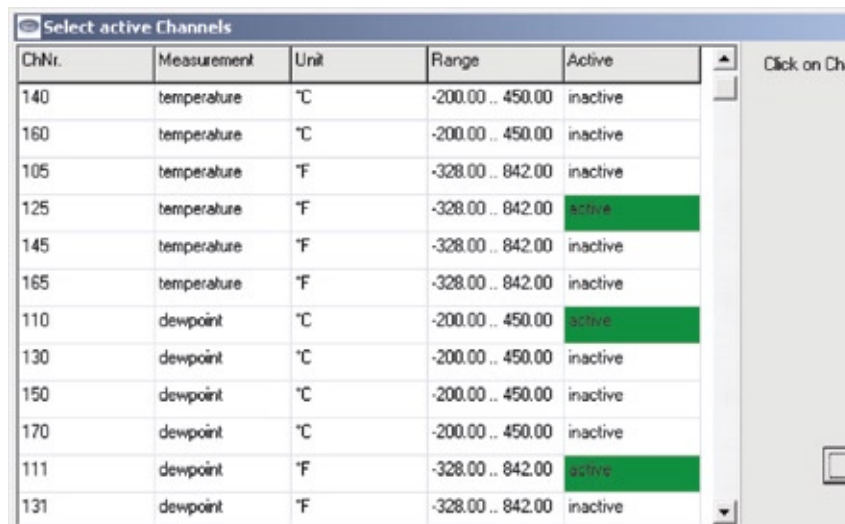

Software Collector / SmartView3

Functions:

Web based visualization and data collection software for Lufft dataloggers/transmitters

Storage of data in database

Flexible export and import functions for integration of external/third party software/data (CSV and XML)

Simultaneous data collection via unlimited communication modules (e.g.modems)

Integration of webcam pictures (via TCP / IP-FTP)

Basis version Collector
(Collector for up to 5 stations)
Order No.: 8160.COLLECT05

Unlimited version Collector
(unlimited quantity of stations)
Order No.: 8160.COLLECT

SmartView3 incl. Collector
up to 5 stations
Order No.: 8040.SV05

SmartView3 incl. Collector
unlimited
(Web visualization)
Order No.: 8040.SV300

New functions:

- Extremely flexible alarm (SMS, email, voicemail)
- 24hr. forecast module

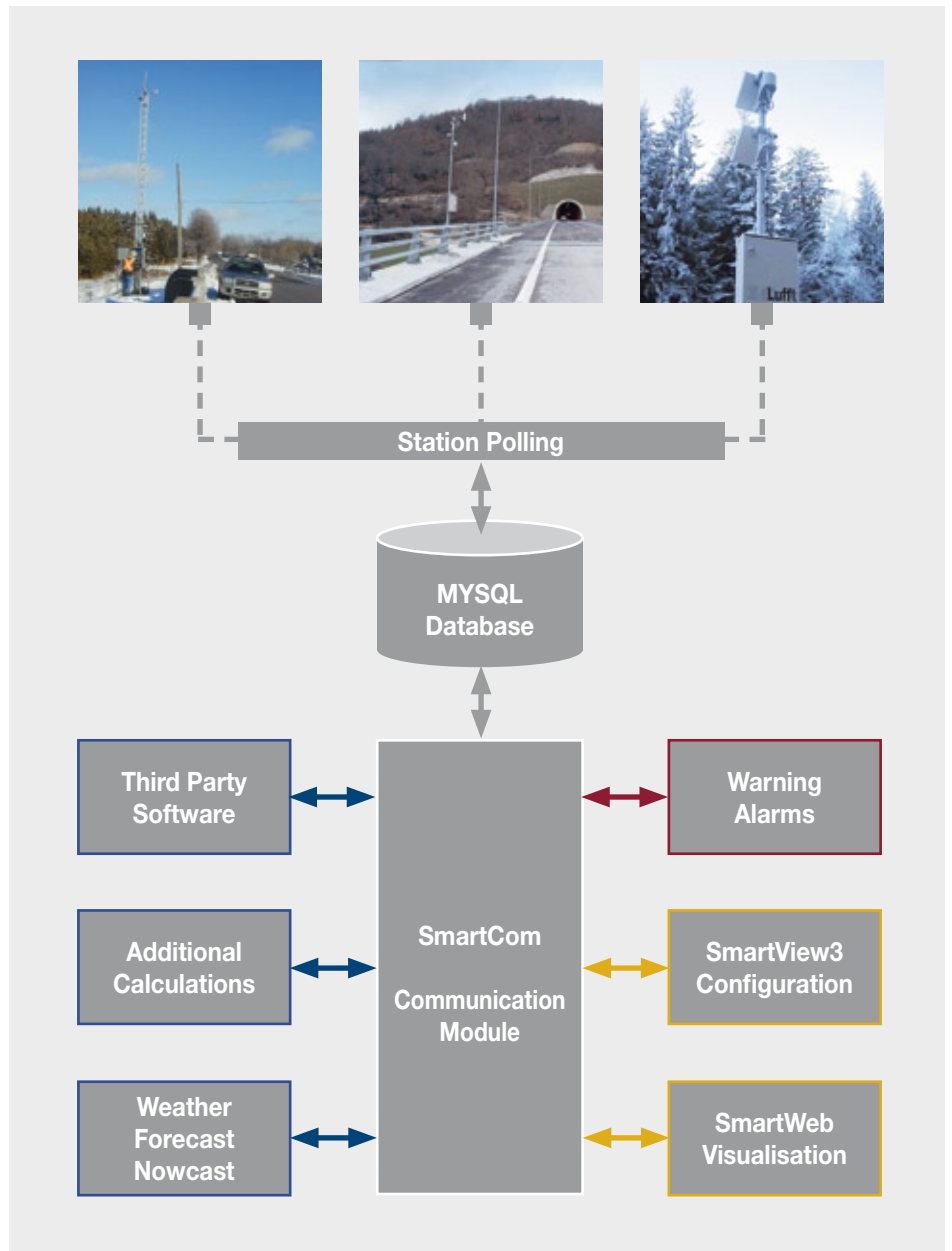

A screenshot of the Lufft software configuration window. It contains several sections for setting up a station, including fields for name, location, and communication settings. There are also checkboxes and buttons for different options.



Good to Know



Road surface temperature: The sensor measures the "sun temperature" 2 mm below the surface. The most important temperature measurement for ice warning systems.

Road depth temperature - Depth 1: The sensor measures at a depth of, for example, 5 cm below the road surface. Typically the road surface temperature graph follows a similar path with a time delay.

Road depth temperature - Depth 2: The sensor measures at a depth of, for example, 30 cm below the road surface. Compared to the road surface temperature the measurement changes very slowly. After a long cold phase the measurement is often below 0 °C, critical road conditions can arise even when the weather changes from "dry/cold" to "warm/humid" and the air temperature is above typical freezing temperature.

Freezing temperature: The IRS-sensor measures the proportion of salt in the water and calculates the freezing temperature. This is the value at which the soluble liquid on the surface freezes (icing).

Water film: The sensor measures the water film height in micrometers. Aquaplaning usually occurs between measurements from 0.7 to 700 micrometers. The higher the water film, the higher the concentration the de-icer must be to prevent freezing. The freezing point is dependent on the concentration of the de-icer and the actual water film height.

Salt concentration: The sensor measures the proportion of salt in the water and cal-

culates the freezing temperature. The salt concentration is equivalent to the freezing temperature.

Road condition: The sensor measures whether the road surface is dry, damp or wet. Dryness, dampness or wetness is determined in accordance with the measured water film height (see above). The sensor also determines critical road conditions (slippery).

Precipitation intensity: The sensor measures and recalculates the precipitation intensity every minute. Typically, this is output as "amount per hour", e.g. 6.8 mm/h = 6.8 [l/m²]/h. The sensor has a very fast response time: the intensity is generally recalculated every 10 minutes.

Precipitation type: The sensor differentiates between the following typical types of precipitation (also described as "present weather"):

- Drizzle
- Rain
- Sleet
- Hail
- Snow

Air temperature: The sensor generally measures the air temperature in an air permeable housing, which protects the sensor against direct radiation and humidity, at a height of 4 m above the road (on the mast). In the event of solar irradiation, the air temperature measurement varies considerably from the road surface temperature.

Dew point: Dew point is the calculated temperature at which the ambient air is unable to absorb any further moisture, i.e. the air releases water in liquid form (mist formation). A road surface temperature below the dew point leads to the formation of frost (at road surface temperature < 0 °C).

Relative humidity: The sensor measures the humidity in the radiation-protected housing generally at a height of 4 m above the road (on the mast). The dew point is calculated on the basis of the relative humidity and air temperature.

Measurement Comparison R2S and "Tipping Bucket"

Time interval: 60 min.
Polling intervall: 1 min.

Device:

Resolution NM R2S

0.01mm

Reaction point NM R2S

0.01mm

Reaction point NI R2S

0.6mm/h (0.01mm x 60min)

Legend:

R2S / Radar sensor Luftt

TP / Tipping bucket

NM / Precipitation quantity

NI / Precipitation intensity

The table shows the difference of measurement resolutions between R2S and a tipping bucket. The R2S has 10 times better resolution than any reed-contact based tipping bucket rain gauge.

This is why 1-minute-measurements can differ. Whereas the tipping bucket needs a minimum amount of 0.1 mm rainfall to generate a measurement, the R2S only needs 0.01 mm rain fall per measurement interval.

Zeitstempel / time stamp	NM R2S in mm	NI R2S in mm/h	NM TP in mm
00:00:00	0,03	1,80	0,00
00:01:00	0,01	0,60	0,00
00:02:00	0,00	0,00	0,00
00:03:00	0,00	0,00	0,00
00:04:00	0,02	1,20	0,00
00:05:00	0,01	0,60	0,00
00:06:00	0,04	2,40	0,10
00:07:00	0,00	0,00	0,00
00:08:00	0,00	0,00	0,00
00:09:00	0,00	0,00	0,00
00:10:00	0,03	1,80	0,00
00:11:00	0,07	4,20	0,10
00:12:00	0,12	7,20	0,10
00:13:00	0,08	4,80	0,10
00:14:00	0,03	1,80	0,00
00:15:00	0,01	0,60	0,00
00:16:00	0,00	0,00	0,00
00:17:00	0,00	0,00	0,00
00:18:00	0,00	0,00	0,00
00:19:00	0,00	0,00	0,00
00:20:00	0,13	7,80	0,10
00:21:00	0,17	10,20	0,20
00:22:00	0,18	10,80	0,20
00:23:00	0,09	5,40	0,10
00:24:00	0,07	4,20	0,00
00:25:00	0,08	4,80	0,10
00:26:00	0,14	8,40	0,20
00:27:00	0,10	6,00	0,10
00:28:00	0,03	1,80	0,00
00:29:00	0,01	0,60	0,00
00:30:00	0,00	0,00	0,00
00:31:00	0,00	0,00	0,00
00:32:00	0,00	0,00	0,00
00:33:00	0,00	0,00	0,00
00:34:00	0,00	0,00	0,00
00:35:00	0,00	0,00	0,00
00:36:00	0,00	0,00	0,00
00:37:00	0,00	0,00	0,00
00:38:00	0,00	0,00	0,00
00:39:00	0,02	1,20	0,00
00:40:00	0,05	3,00	0,10
00:41:00	0,07	4,20	0,00
00:42:00	0,13	7,80	0,20
00:43:00	0,18	10,80	0,20
00:44:00	0,16	9,60	0,10
00:45:00	0,09	5,40	0,10
00:46:00	0,05	3,00	0,10
00:47:00	0,03	1,80	0,00
00:48:00	0,01	0,60	0,00
00:49:00	0,00	0,00	0,00
00:50:00	0,00	0,00	0,00
00:51:00	0,00	0,00	0,00
00:52:00	0,00	0,00	0,00
00:53:00	0,06	0,00	0,10
00:54:00	0,00	0,00	0,00
00:55:00	0,00	0,00	0,00
00:56:00	0,00	0,00	0,00
00:57:00	0,00	0,00	0,00
00:58:00	0,00	0,00	0,00
00:59:00	0,00	0,00	0,00
Summe	2,30	Ø 134,40	2,30

Standard-Certificate for all UMB-Sensors

Inspection certificate DIN EN 10204/3.1

ZERTIFIZIERT
DIN ISO 9001
NR 70100 222
CERTIFIED



Compact Weather Station

Model Type	WS600-UMB	
Serial Number	006 0911 0813 025	

This is to certify, that this Lufft product has been tested according to the TQM of the G. LUFFT Mess- und Regeltechnik GmbH manual in accordance with DIN EN ISO 9001. Ordering specifications are complied with. Execution of instruments / systems as well as testing of accuracy was carried out following LUFFT quality assurance procedures. Quality inspection was successfully passed.

Measurements

	Reference Value	Actual Value	Status
Relative Humidity	54,5%	54,3%	✓
Temperature	5,99 °C	5,75 °C	✓
Air Pressure	979,6 hPa	981,0 hPa	✓

Precipitation

	Reference Value	Actual Value	Status
Drop Size Small	0,115 mm	0,116 mm	✓
Drop Size Medium	0,670 mm	0,674 mm	✓
Drop Size Large	2,730 mm	2,716 mm	✓

Wind Direction and Speed

Angular Deviation

	2,0 m/s	5,0 m/s	10,0 m/s	20,0 m/s	50,0 m/s	Status
RMSE	1,3°	1,0°	0,9°	0,8°	0,7°	✓

Wind Speed

	2,0 m/s	5,0 m/s	10,0 m/s	20,0 m/s	50,0 m/s	Status
RMS	2,0 m/s	5,0 m/s	10,0 m/s	20,1 m/s	50,3 m/s	✓

Date	Inspector	Quality Management
18042011	 i. A. Martin Wyrambik	i. A. Helmut Hager

G. LUFFT Mess- und Regeltechnik GmbH
Gutenbergstrasse 20
70736 Fellbach
Germany

Phone: +49-711-51822-0
Fax: +49-711-51822-41
E-Mail: info@lufft.de

Managing Director
Dipl.-Wirtsch.-Ing. Klaus Hirzel
Dipl.-Ing. Axel Schmitz-Hübsch



Evaluate, React, and
Decide



Measurements

Please note:

- Road surface temperature below 0 degrees Celsius and below dew point causes frost.
- Liquid precipitation (rain) on frozen ground causes black ice (subsurface road temperature below 0 degrees Celsius).



Integration of a camera image into the visualization

Graphical displays (day and week charts)

Measurement data in tabular form

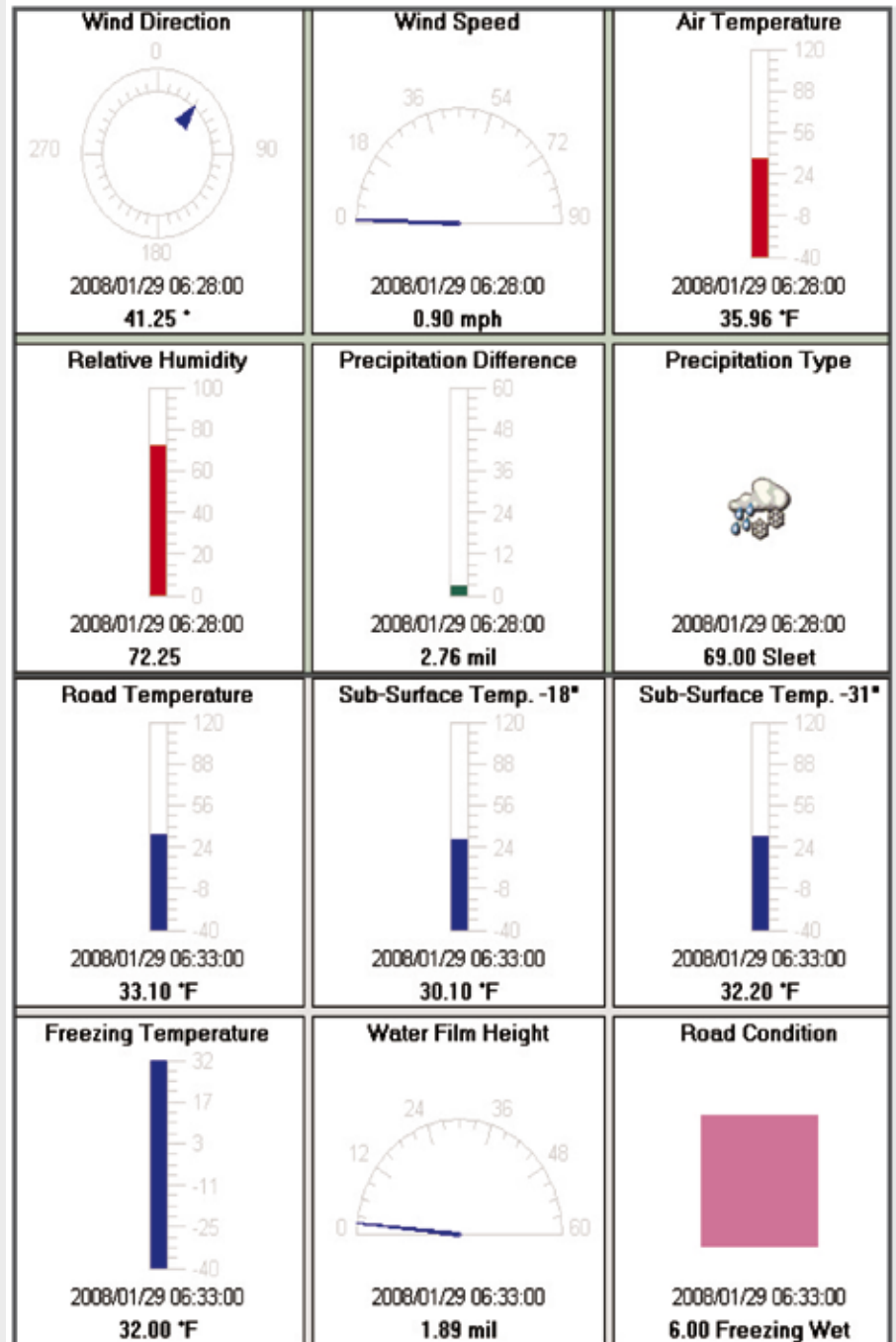

SmartView3 Functions Overview

Functions Overview of SmartView3 1.8.2 (as of 2011)				
	Collector (Basic)	Collector (Unlimited)	Full (up to 5 stations)	Full (up to 300 stations)
Data transfer				
Quantity of weather stations	max. 5	unlimited	max. 5	unlimited
Types of stations				
Station type Opus200 (on-and offline)	■	■	■	■
Station type Opus2 (on-and offline)	■	■	■	■
Station type UMB (online)	■	■	■	■
Station type HP100 (offline)	■	■	■	■
Read sensor configurations	all types	all types	all types	all types
Change sample and storage rate and memory mode (Min/Max/ave)	for OPUS200	for OPUS200	for OPUS200	for OPUS200
Station type "import"	■	■	■	■
Station type "TLSoIP"	■	■	■	■
Station type "Boschung TLS"	■	■	■	■
Station type „MSSI“	■	■	■	■
Station type „NTCIP“	■	■	■	■
Transfer camera picture via FTP	■	■	■	■
Transfer camera picture via HTTP	■	■	■	■
Transfer camera picture via MSSI	■	■	■	■
Transfer camera picture via NTCIP	■	■	■	■
Connections				
Direct (RS232)	■	■	■	■
TCP/IP (Station with COM Server or CDMA/GPRS Modem with fixed IP address or DynDNS support)	■	■	■	■
Modem (TAPI)	■	■	■	■
PPP (camera picture only)	■	■	■	■
PPP (for NTCIP)	■	■	■	■
Intervals				
Fixed (e. g. every 20 minutes)	■	■	■	■
No transfer at special night periods (e. g. not between 10.00 p. m. and 5.00 a. m.)	■	■	■	■
Special times	■	■	■	■
Modem poll				
Max quantity of modems	unlimited	unlimited	unlimited	unlimited
"Modem Pools" (poll stations with dedicated modems)	■	■	■	■
Recalculation of values				
Re-scale data before storing in the database	■	■	■	■
Mapping of data before storing in the database (e. g. change of road conditions codes)	■	■	■	■
Clock synchronization				
Synchronization of device clock (datalogger) through PC clock device clock can be UTC or local time (with or without summertime adjustment)	■	■	■	■
Calculation channel				
Calculation of sensor data as "calculation channel" according to delivered raw data. Immediately: scale of raw data for a configurable coefficient, generation of sum/average/minimum value/maximum value for a specific period of time, mapping of the values	■	■	■	■
Logic sensor types				
Same presentation of channels of different stations such as OPUS200 and OPUS208 and UMB	■	■	■	■
Hide/delete measured values of channels dependent upon another channel (e.g. hide freezing point if no residual salt is detected)	■	■	■	■

Functions Overview of SmartView3 1.8.2 (as of 2011)				
	Collector (Basic)	Collector (Unlimited)	Full (up to 5 stations)	Full (up to 300 stations)
Backup/archive of data				
Time-controlled automatic backup of full database	■	■	■	■
Time-controlled deletion of old data in database (including backup of data before deletion starts)	■	■	■	■
Time-controlled compression of data in the database including backup before compression starts (reduction of data down to one value per hour/day)	■	■	■	■
Time-controlled deletion of "old" camera pictures in the database (including backup of data before deletion starts)	■	■	■	■
Restore of backup-data - including deletion of compressed data before restoring process starts (if the backup is the result of a data compression)	■	■	■	■
Automatic transfer of backup-file onto a server via FTP	■	■	■	■
User access administration				
Administration of users / functions and user groups	■	■	■	■
Admission to functions for users/groups	■	■	■	■
Create/delete stations	■	■	■	■
Edit/view configuration of a station	■	■	■	■
Create/delete website			■	■
Change configuration of website			■	■
Edit/view configuration of website			■	■
Create/change user	■	■	■	■
Change configuration data of software	■	■	■	■
Export/Import				
Manual Export/Import			■	■
Automatic Export/Import			■	■
Export of configurable values of one or more stations in one file			■	■
Export in "CSV" format incl. parameter settings			■	■
Import in "CSV" format incl. parameter settings			■	■
Export as a "Hex Dump of a TLS Telegram"			■	■
Export in "XML" format incl. parameter settings			■	■
Scale of data for export (e. g. recalculation of m/s into km/h)			■	■
Mapping of data for export (e. g. recalculation of road conditions codes)			■	■
Scale of import-data before storing the data in the database			■	■
Mapping of import-data before storing the data in the database			■	■
Configuration of export/import jobs (mainly for plan disease calculations)			■	■
Different export-import modules such as disease calculation models, dew point calculation, road forecast (24h)			■	■
External software modules for Export/Import				
External software module for the dew point and vaporation pressure calculation			■	■
External software for the combined road condition calculation			■	■
External software for the calculation „alarm road condition“			■	■

SmartView3 Functions Overview

Functions Overview of SmartView3 1.8.2 (as of 2011)				
	Collector (Basic)	Collector (Unlimited)	Full (up to 5 stations)	Full (up to 300 stations)
External modules for agricultural applications				
Apple Scab (<i>Venturia inaequalis</i>)	■	■	■	■
Onion: Downey Mildew (<i>Peronospora destructor</i>)	■	■	■	■
Onion: Neck Rot (<i>Bortyis squamosa</i>)	■	■	■	■
Carrot Alternariosis (<i>Alternaria dauci</i> , <i>A. radicina</i>)	■	■	■	■
Potato: Late Blight (<i>Phytophthora infestans</i>)	■	■	■	■
Fire Blight (<i>Erwinia amyloflora</i>)	■	■	■	■
Strawberry: Grey mould (<i>Botrytis cinera</i>)	■	■	■	■
Beetroot: Leaf Spot (<i>Cercospora spp.</i>)	■	■	■	■
Grape Vine Downey Mildew (<i>Plasmopara viticola</i>)	■	■	■	■
Grape Vine Powdery Mildew (<i>Unicula necator</i>)	■	■	■	■
Bortyis Bunch Rot (<i>Botrytis cinerea</i>)	■	■	■	■
Seljaninov Hydrothermal Coefficient	■	■	■	■
Calculation channels				
Internal calculation of sensor data as "calculation channel" according to imported raw data. Scale of raw data for a configurable coefficient, generation of sum/average/minimum value/maximum value for a specific period of time; differential calculation with previous value; mapping of the values in a configurable table			■	■
Control of automatic import/export				
Export if new data has been stored			■	■
Time-controlled export (e.g. every 5 minutes)			■	■
Flexible definition of time-interval for export based on start-uptime			■	■
Export and execution of a software program			■	■
Export and automatic transfer of a file via FTP			■	■
Export and execution of a software program and import of the calculated result (e.g. disease model calculation)			■	■
FTP transfer of files before import starts			■	■
Time-controlled FTP transfer of files including "Wildcard" support			■	■
Automatic deletion of files transferred via FTP after transfer has been finished			■	■
Import of files including "Wildcard" support			■	■
Automatic deletion of import files after import has been finished			■	■
Visualization of data as "website"				
Indication of station's status (last data transfer, transfer success) in a table			■	■
Indication of station's status (last data transmission, transfer success) on a static map			■	■
Indication of (selected) sensor data in a "pop-up" window by "scroll over" with the mouse on a station, on the static map			■	■
Indication of status-information and current values of stations on "stations-page" per station			■	■
Indication of camera-picture on "stations-page" of a station			■	■
Graphic indication of the current value on the "station page" in the form of an analog-instrument			■	■
Indication of reports (day/month/year) with sum/average and extreme values during the report period of time, on the "station page"			■	■
Automatic generation of "data pages" to indicate the data in the given time interval, day/week/month/year (diagram and table)			■	■

Functions Overview of SmartView3 1.8.2 (as of 2011)				
	Collector (Basic)	Collector (Unlimited)	Full (up to 5 stations)	Full (up to 300 stations)
Visualization of data as "website", continued				
Selectable "data pages" including current values from sensors of different stations and different storage intervals (day/week/month/year) on one page			■	■
Selectable line and status (bar) diagrams on "data-pages"; line diagrams with up to 4 different Y-axes (units). Scale of line diagrams manually or automatically-no other periods.			■	■
Indication of reports (depending on configured period for the station pages) with average/sum and extreme values on the period of time, on the station page			■	■
Management of "pages-archive" for data pages (historic measurements)			■	■
Automatic transfer of admission rights on to website/webserver (cia .htaccess – function has to be active on web-server)			■	■
Automatic erasure of archive pages prior to configured period of time			■	■
Free configuration of text elements for data pages and stations pages			■	■
Archive of pictures			■	■
Easy configuration of stations pages and data pages via templates			■	■
Overview-table with current readings of all stations			■	■
Configuration of time-offsets for stations in different time zones			■	■
Group-status page(s) with sensor values and camera pictures			■	■
Freely configurable diagrammes with data from the last 12/24 hours on the stations' pages			■	■
Optional hide function of "non-available" measured values (e.g. residual salt with TLS)			■	■
Several linked map layers			■	■
Separate configuration of „pop-up information“ to the stations (sensor value) from the overview table			■	■
Option of several overview tables (per map representation)			■	■
Optional automatic adjustment of map size to browser window			■	■
„Only camera“ stations (stations without sensors)			■	■
Identification of stations with cameras /only camera on the map representation with corresponding icons			■	■
Menu optionally as a „hierarchical pop-up menu“			■	■
Nested/hierarchical grouping of stations in the pop-up menus			■	■
Warnings and alarms				
Configuration of high and low threshold per sensor; generation of warnings/alarms if value is out of limits			■	■
Alarm message if station cannot be polled			■	■
Alarm message if import file cannot be used			■	■
In case of alarms, generation of email message (station could not be polled, sensor delivers error, sensor delivers error value/import, sensor delivers error / import, sensor delivers alarm value) to one or more destination addresses			■	■
Warning/alarm based on a condition value (road state)			■	■
SMS messages including alarm/warning contents to one or multiple destinations			■	■
Warning/alarm in case of violating selected thresholds			■	■
Selectable time frames for SMS alarms transmissions			■	■
Configuration of minimum time intervals between alarm messages			■	■
Configuration of time to repeat alarm messages			■	■

References

Siemens AG, Munich
Weiss Elektronik, Trier
Dambach AG, Gaggenau
North Bavaria Highways Directorate
Schleswig-Holstein State Highways Office
Federal State of Salzburg
Federal State of Upper Austria
Federal State of Carinthia
New York State
Sagem, Hungary
Telvent, Spain



Measurement



Storage and Transfer



Representation and Evaluation



Qualification and Calibration



Alarm

G. Lufft Mess-und
Regeltechnik GmbH

Address:
P.O. Box 4252
70719 Fellbach
Germany

Postal Address:
Gutenbergstrasse 20
70736 Fellbach
Germany

Tel: +49 711 51822-15
Fax: +49 711 51822-41

www.lufft.com
info@lufft.de

