

PR
electronics

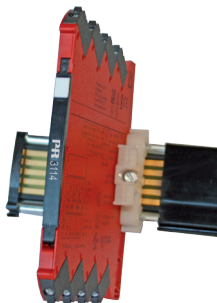

3 1 1 4

**Isolated Universal
Converter**

No. 3114V101-UK



- DK** ▶ PR electronics A/S tilbyder et bredt program af analoge og digitale signalbehandlingsmoduler til industriel automation. Programmet består af Isolatorer, Displays, Ex-barrierer, Temperaturtransmittere, Universaltransmittere mfl. Vi har modulerne, du kan stole på i selv barske miljøer med elektrisk støj, vibrationer og temperaturudsving, og alle produkter opfylder de strengeste internationale standarder. Vores motto »Signals the Best« er indbegrebet af denne filosofi – og din garanti for kvalitet.
- UK** ▶ PR electronics A/S offers a wide range of analogue and digital signal conditioning devices for industrial automation. The product range includes Isolators, Displays, Ex Interfaces, Temperature Transmitters, and Multifunctional Devices. You can trust our products in the most extreme environments with electrical noise, vibrations and temperature fluctuations, and all products comply with the most exacting international standards. »Signals the Best« is the epitome of our philosophy – and your guarantee for quality.
- FR** ▶ PR electronics A/S offre une large gamme de produits pour le traitement des signaux analogiques et numériques dans tous les domaines industriels. La gamme de produits s'étend des transmetteurs de température aux afficheurs, des isolateurs aux interfaces SI, jusqu'aux modules universels. Vous pouvez compter sur nos produits même dans les conditions d'utilisation sévères, p.ex. bruit électrique, vibrations et fluctuations de température. Tous nos produits sont conformes aux normes internationales les plus strictes. Notre devise »SIGNALS the BEST« c'est notre ligne de conduite - et pour vous l'assurance de la meilleure qualité.
- DE** ▶ PR electronics A/S verfügt über ein breites Produktprogramm an analogen und digitalen Signalverarbeitungsgeräte für die industrielle Automatisierung. Dieses Programm umfasst Displays, Temperaturtransmitter, Ex- und galvanische Signaltrenner, und Universalgeräte. Sie können unsere Geräte auch unter extremen Einsatzbedingungen wie elektrisches Rauschen, Erschütterungen und Temperaturschwingungen vertrauen, und alle Produkte von PR electronics werden in Übereinstimmung mit den strengsten internationalen Normen produziert. »Signals the Best« ist Ihre Garantie für Qualität!

ISOLATED UNIVERSAL CONVERTER

3114

CONTENTS

Warning	2
Safety instructions.....	4
UL installation	4
cFMus installation in Division 2 or Zone 2	5
IECEX, ATEX installation in Zone 2	5
Flexible supply	7
Mounting and demounting of system 3000	8
Installation on DIN rail	9
Supply of power rail	9
Side label.....	9
Highlights	10
Advanced features	10
Applications.....	10
Technical characteristics	10
Product overview	11
PR 4501 Display / programming front	12
ConfigMate 4590 adapter	13
Display readout on the 4501 of sensor error detection and input signal outside range	19
Sensor error detection limits	19
Error indications	20
Connections	21
Installation on power rail	22
Marking.....	23
LED indication	24
Default configuration	25
Configuration / operating the function keys	26
Routing diagram.....	30
Routing diagram, Advanced settings (ADV.SET).....	31
Scrolling help text in display line 3	32

NB.: Click on the entries in the table of contents to go to the desired section.



GENERAL

WARNING

To avoid the risk of electric shock and fire, the safety instructions of this manual must be observed and the guidelines followed. The specifications must not be exceeded, and the device must only be applied as described in the following.

Prior to the commissioning of the device, this manual must be examined carefully.

Only qualified personnel (technicians) should install this device. If the equipment is used in a manner not specified by the manufacturer, the protection provided by the equipment may be impaired.

Until the device is fixed, do not connect hazardous voltages to the device.

Repair of the device must be done by PR electronics A/S only.



**HAZARD-
OUS
VOLTAGE**

WARNING

In applications where hazardous voltage is connected to in-/outputs of the device, sufficient spacing or isolation from wires, terminals and enclosure to surroundings (incl. neighbouring devices), must be ensured to maintain protection against electric shock.

The connector behind the front cover of 3114 is connected to the input terminals on which dangerous voltages can occur.



CAUTION

Potential electrostatic charging hazard. To avoid the risk of explosion due to electrostatic charging of the enclosure, do not handle the units unless the area is known to be safe, or appropriate safety measures are taken to avoid electrostatic discharge.

SYMBOL IDENTIFICATION



Triangle with an exclamation mark: Read the manual before installation and commissioning of the device in order to avoid incidents that could lead to personal injury or mechanical damage.



The CE mark proves the compliance of the device with the essential requirements of the directives.



Ex devices have been approved according to the ATEX directive for use in connection with installations in explosive areas.

SAFETY INSTRUCTIONS

RECEIPT AND UNPACKING

Unpack the device without damaging it and check whether the device type corresponds to the one ordered. The packing should always follow the device until this has been permanently mounted.

ENVIRONMENT

Avoid direct sunlight, dust, high temperatures, mechanical vibrations and shock, as well as rain and heavy moisture. If necessary, heating in excess of the stated limits for ambient temperatures should be avoided by way of ventilation. All devices can be used for Measurement Category II and Pollution Degree 2. The module is designed to be safe at least under an altitude up to 2 000 m.

MOUNTING

Only technicians who are familiar with the technical terms, warnings, and instructions in the manual and who are able to follow these should connect the device.

Should there be any doubt as to the correct handling of the device, please contact your local distributor or, alternatively,

PR electronics A/S
www.prelectronics.com

Mounting and connection of the device should comply with national legislation for mounting of electric materials, i.e. wire cross section, protective fuse, and location.

Descriptions of input / output and supply connections are shown in this manual and on the side label.

The device is provided with field wiring terminals and shall be supplied from a Power Supply having double / reinforced insulation. A power switch should be easily accessible and close to the device. The power switch shall be marked as the disconnecting unit for the device.

SYSTEM 3000 must be mounted on a DIN rail according to EN 60715.

UL INSTALLATION

Use 60/75°C copper conductors only.

Wire size AWG 26-12

UL file number E314307

The device is an Open Type Listed Process Control Equipment. To prevent injury resulting from accessibility to live parts the equipment must be installed in an enclosure.

The power supply unit must comply with NEC Class 2, as described by the National Electrical Code® (ANSI / NFPA 70).

cFMus INSTALLATION IN DIVISION 2 OR ZONE 2

Class I, Div. 2, Group A, B, C, D T4 or I, Zone 2, AEx nA IIC T4 or Ex nA IIC T4.

In class I, Division 2 or Zone 2 installations, the subject equipment shall be mounted within a tool-secured enclosure which is capable of accepting one or more of Class I, Division 2 wiring methods specified in the National Electrical Code (ANSI/NFPA 70) or in Canada in the Canadian Electrical Code (C22.1).

The 3000 System Isolators and Converters must be connected to limited output NEC Class 2 circuits, as outlined in the National Electrical Code® (ANSI / NFPA 70), only. If the devices are connected to a redundant power supply (two separate power supplies), both must meet this requirement.

Where installed in outdoor or potentially wet locations the enclosure shall at a minimum meet the requirements of IP54.

Warning: Substitution of components may impair suitability for zone 2 / division 2.

Warning: To prevent ignition of the explosive atmospheres, disconnect power before servicing and do not separate connectors when energised and an explosive gas mixture is present.

Warning: Do not mount or remove devices from the power rail when an explosive gas mixture is present.

IECEX, ATEX INSTALLATION IN ZONE 2

IECEX KEM 10.0068 X..... Ex nA IIC T4 Gc

KEMA 10ATEX0147 X..... II 3G Ex nA IIC T4 Gc

For safe installation the following must be observed. The device shall only be installed by qualified personnel who are familiar with the national and international laws, directives and standards that apply to this area.

Year of manufacture can be taken from the first two digits in the serial number.

The devices shall be installed in a suitable enclosure providing a degree of protection of at least IP54 according to EN60529, taking into account the environmental conditions under which the equipment will be used.

When the temperature under rated conditions exceeds 70°C at the cable or conduit entry point, or 80°C at the branching point of the conductors, the temperature specification of the selected cable shall be in compliance with the actual measured temperature.

Provisions shall be made to prevent the rated voltage from being exceeded by transient disturbances of more than 40%.

For installation on power rail in zone 2, only Power Rail type 9400 supplied by Power Control Unit type 9410 is allowed.

To prevent ignition of the explosive atmospheres, disconnect power before servicing and do not separate connectors when energised and an explosive gas mixture is present.

Do not mount or remove devices from the power rail when an explosive gas mixture is present.

CLEANING

When disconnected, the device may be cleaned with a cloth moistened with distilled water.

LIABILITY

To the extent the instructions in this manual are not strictly observed, the customer cannot advance a demand against PR electronics A/S that would otherwise exist according to the concluded sales agreement.

FLEXIBLE SUPPLY

The units can be supplied with 24 VDC \pm 30% via direct wiring and a loop between the devices. This permits the supply of up to 130 units.

Protective fuse: 2.5 A.



Protective fuse: 0.4 A.

Alternatively, the 24 V supply voltage can be distributed via a power rail that receives the voltage from another connected unit (3103, -04, -05, -08, -09, or -14). In this way up to 20 units can be supplied.

Fuse characteristics: The 2.5 A fuse must break after not more than 120 seconds at 6.4 A.

The power connector unit 3405 is a standalone supply unit which supplies the power rail. With 3405, up to 100 units can be supplied.

Protective fuse: 2.5 A.

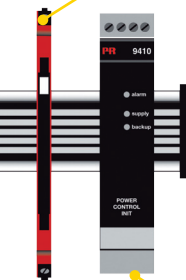

Protective fuse: PR 9410.

With the power control unit 9410 redundant supply is possible. This solution can supply up to 200 units.

MOUNTING AND DEMOUNTING OF SYSTEM 3000

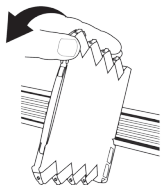

Picture 1:

Mounting on DIN rail / power rail.

Click the device onto the rail

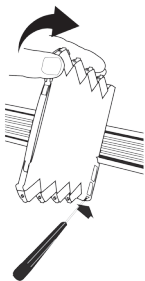

Picture 2:

Demounting from DIN rail / power rail .

First, remember to demount the connectors with hazardous voltages. Detach the device from the rail by lifting the bottom lock.

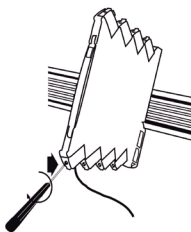

Picture 3:

Wire size 0.13 x 2.5 mm² stranded wire.

Screw terminal torque 0.5 Nm.

INSTALLATION ON DIN RAIL

To avoid short circuit between the power rail connectors on the 3000 devices and the screws holding the 7.5 mm DIN rail, the head of the screws shall be no more than 3.5 mm high.

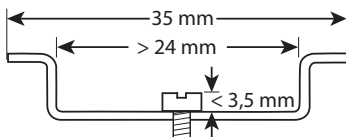

SUPPLY OF POWER RAIL

It is possible to supply the power rail via the supply terminals. The terminals can pass a current of max. 400 mA.

SIDE LABEL

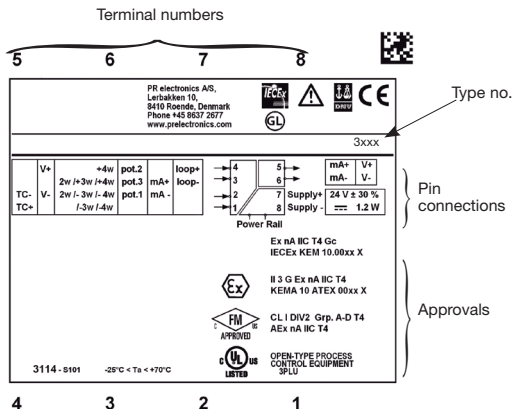

ISOLATED UNIVERSAL CONVERTER

3114

Highlights

- *Input for RTD, TC, Ohm, potentiometer, mA and V*
- *2-wire supply > 15 V*
- *I.S. approvals: FM Div. 2, ATEX Zone 2, IECEx Zone 2*
- *Output for current and voltage*

Advanced features

Programmable by way of detachable display front (4501) and ConfigMate 4590, process calibration, signal simulation, password protection, error diagnostics and help text available in several languages.

Applications

- Linearised, electronic temperature measurement with RTD or TC sensor.
- Conversion of linear resistance variation to a standard analogue current / voltage signal, i.e. from solenoids and butterfly valves or linear movements with attached potentiometer.
- Power supply and signal isolator for 2-wire transmitters.
- Process control with standard analogue output.
- Galvanic separation of analogue signals and measurement of floating signals.

Technical characteristics

- When 3114 is used in combination with the 4501 display / programming front and ConfigMate 4590, all operational parameters can be modified to suit any application. As the 3114 is designed with electronic hardware switches, it is not necessary to open the device for setting of DIP-switches.
- A green front LED indicates normal operation and malfunction.
- Continuous check of vital stored data for safety reasons.
- 3-port 2.5 kVAC galvanic isolation.

Product overview

PR type no.	3114
PR product name	Isolated universal converter
Description	Universal DC / DC and temperature converter with loop supply output
Parameterisation	4501 / ConfigMate 4590
Input signal	RTD, TC and potentiometer 2-, 3-, and 4-wire 0...10 V 0...20 mA
Sensor type	All standard Pt, Ni, TC
CJC sensor	Internal Pt100
Loop supply output	> 15 V @ 20 mA
Output signal (active)	0...20 mA / 0...10 V
Approvals	UL, safety / FM Div. 2 / ATEX zone 2 / IECEX Zone 2 / DNV, marine / GL, marine

PR 4501 DISPLAY / PROGRAMMING FRONT



Functionality

The simple and easily understandable menu structure and the explanatory help texts guide you effortlessly and automatically through the configuration steps, thus making the product very easy to use. Functions and configuration options are described in the section "Configuration /operating the function keys".

Application

- Communications interface for modification of operational parameters in 3114.
- Can be moved from one 3114 device to another and download the configuration of the first device to subsequent devices.

Technical characteristics

- LCD display with 4 lines; Line 1 (H=5.57 mm) shows input signal, line 2 (H=3.33 mm) shows units, line 3 (H=3.33 mm) shows analogue output or tag no. and line 4 shows communication status.
- Programming access can be blocked by assigning a password. The password is saved in the device in order to ensure a high degree of protection against unauthorised modifications to the configuration.

Mounting / installation

- Click 4501 into the adapter ConfigMate 4590 and connect the adapter to 3114.

CONFIGMATE 4590 ADAPTER

Connect the adapter by opening the front plate on 3114 and inserting the jack into the plug.

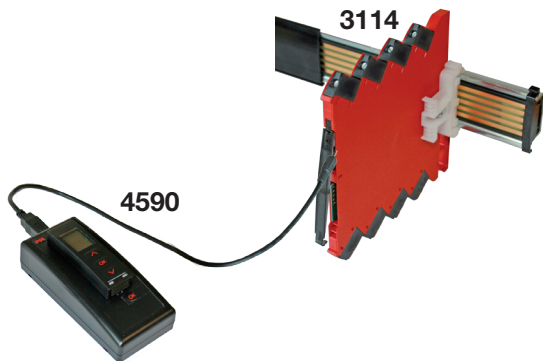

Once configuration of the device with 4501 has been terminated, the parameters can be transferred into the PC-based PReset program. The included USB cable is connected between ConfigMate 4590 and the USB port of the computer and the PC will then automatically retrieve the necessary driver from the internet. For further instructions regarding use of the PReset software, please consult the manual for PReset 5909.



Order codes:**3114 = Isolated universal converter****4501 = Display / programming front****4590 = ConfigMate adapter****Electrical specifications:**

Specifications range..... -25°C to +70°C

Common specifications:

Supply voltage, universal 16.8...31.2 VDC

Max. consumption..... 1.2 W

Fuse..... 400 mA SB / 250 VAC

Isolation voltage, test / working 2.5 kVAC / 300 VAC / 250 VAC (Ex)

Communications interface Programming front 4501 /
ConfigMate 4590

Signal / noise ratio Min. 60 dB (0...100 kHz)

Response time (0...90%, 100...10%):

Temperature input..... 1 s

mA / V input 400 ms

Calibration temperature..... 20...28°C

Accuracy, the greater of the general and basic values:

General values		
Input type	Absolute accuracy	Temperature coefficient
All	$\leq \pm 0.1\%$ of span	$\leq \pm 0.01\%$ of span / °C

Basic values		
Input type	Basic accuracy	Temperature coefficient
mA	$\leq \pm 16 \mu\text{A}$	$\leq \pm 1.6 \mu\text{A} / ^\circ\text{C}$
0...1 V & 0.2...1 V	$\leq \pm 0.8 \text{ mV}$	$\leq \pm 0.08 \text{ mV} / ^\circ\text{C}$
0...5 V, 1...5 V, 0...10 V & 2...10 V	$\leq \pm 8 \text{ mV}$	$\leq \pm 0.8 \text{ mV} / ^\circ\text{C}$
Pt100, Pt200, Pt 1000	$\leq \pm 0.2^\circ\text{C}$	$\leq \pm 0.02^\circ\text{C} / ^\circ\text{C}$
Pt500, Ni100, Ni120, Ni 1000	$\leq \pm 0.3^\circ\text{C}$	$\leq \pm 0.03^\circ\text{C} / ^\circ\text{C}$
Pt50, Pt400, Ni50	$\leq \pm 0.4^\circ\text{C}$	$\leq \pm 0.04^\circ\text{C} / ^\circ\text{C}$
Pt250, Pt300	$\leq \pm 0.6^\circ\text{C}$	$\leq \pm 0.06^\circ\text{C} / ^\circ\text{C}$
Pt20	$\leq \pm 0.8^\circ\text{C}$	$\leq \pm 0.08^\circ\text{C} / ^\circ\text{C}$
Pt10	$\leq \pm 1.4^\circ\text{C}$	$\leq \pm 0.14^\circ\text{C} / ^\circ\text{C}$
TC type: E, J, K, L, N, T, U	$\leq \pm 1^\circ\text{C}$	$\leq \pm 0.1^\circ\text{C} / ^\circ\text{C}$
TC type: R, S, W3, W5, LR	$\leq \pm 2^\circ\text{C}$	$\leq \pm 0.2^\circ\text{C} / ^\circ\text{C}$
TC type: B 160...400°C	$\leq \pm 4.5^\circ\text{C}$	$\leq \pm 0.45^\circ\text{C} / ^\circ\text{C}$
TC type: B 400...1820°C	$\leq \pm 2^\circ\text{C}$	$\leq \pm 0.2^\circ\text{C} / ^\circ\text{C}$

Conducted RF/LF immunity influence	$< \pm 0.5\%$ of span
Extended EMC immunity: ESD / HF / Burst / Surge immunity influence	$< \pm 1\%$ of span

Auxiliary supplies:

2-wire supply (terminal 3 and 4)..... 25...15 VDC / 0...20 mA
 Max. wire size..... 0.13...2.5 mm² stranded wire
 Screw terminal torque 0.5 Nm
 Relative humidity < 95% RH (non-cond.)
 Dimensions..... 113 x 6.1 x 115 mm
 Protection degree..... IP20
 Weight 70 g

RTD, linear resistance and potentiometer input:

Input type	Min. value	Max. value	Standard
Pt100	-200°C	+850°C	IEC60751
Ni100	-60°C	+250°C	DIN 43760
Lin. R	0 Ω	10000 Ω	-
Potentiometer	10 Ω	100 kΩ	-

Input for RTD types:

Pt10, Pt20, Pt50, Pt100, Pt200, Pt250, Pt300, Pt400, Pt500, Pt1000
Ni50, Ni100, Ni120, Ni1000

Cable resistance per wire (max.), RTD..... 50 Ω

Sensor current, RTD..... Nom. 0.2 mA

Effect of sensor cable resistance

(3- / 4-wire), RTD..... < 0.002 Ω / Ω

Sensor error detection, RTD Yes

Short circuit detection, RTD..... < 15 Ω

TC input:

Type	Min. value	Max. value	Standard
B	0°C	+1820°C	IEC 60584-1
E	-100°C	+1000°C	IEC 60584-1
J	-100°C	+1200°C	IEC 60584-1
K	-180°C	+1372°C	IEC 60584-1
L	-200°C	+900°C	DIN 43710
N	-180°C	+1300°C	IEC 60584-1
R	-50°C	+1760°C	IEC 60584-1
S	-50°C	+1760°C	IEC 60584-1
T	-200°C	+400°C	IEC 60584-1
U	-200°C	+600°C	DIN 43710
W3	0°C	+2300°C	ASTM E988-90
W5	0°C	+2300°C	ASTM E988-90
LR	-200°C	+800°C	GOST 3044-84

Cold junction compensation (CJC)

via internal CJC sensor..... $\pm(2.0^{\circ}\text{C} + 0.4^{\circ}\text{C} * \Delta t)$ Δt = internal temperature - ambient temperature

Sensor error detection, all TC types Yes

Sensor error current:

when detecting Nom. 2 μA

else..... 0 μA

Current input:

Measurement range	0...20 mA
Programmable measurement ranges	0...20 and 4...20 mA
Input resistance	Nom. 20 Ω + PTC 50 Ω
Sensor error detection:	
Loop break 4...20 mA	Yes

Voltage input:

Measurement range	0...12 VDC
Programmable measurement ranges	0...1 / 0.2...1 / 0...5 / 1...5 / 0...10 and 2...10 VDC
Input resistance	Nom. 10 M Ω

Current output:

Signal range (span)	0...20 mA
Programmable signal ranges	0...20 / 4...20 / 20...0 / 20...4 mA
Load (max.)	20 mA / 600 Ω / 15 VDC
Load stability	\leq 0.01% of span / 100 Ω
Sensor error detection	0 / 3.5 / 23 mA / none
NAMUR NE 43 Upscale / Downscale	23 mA / 3.5 mA
Output limitation:	
on 4...20 and 20...4 mA signals	3.8...20.5 mA
on 0...20 and 20...0 mA signals	0...20.5 mA
Current limit	\leq 28 mA

Voltage output:

Signal range	0...10 VDC
Programmable signal ranges	0...1 / 0.2...1 / 0...10 / 0...5 / 1...5 / 2...10 / 1...0 / 1...0.2 / 5...0 / 5...1 / 10...0 og 10...2 V
Load (min.)	>10 k Ω

Approvals

Det Norske Veritas, Ships & Offshore	Stand. f. Certification No. 2.4
Germanischer Lloyd	V1-7-2
ATEX 94/9/EC	EN 60079-0, -15
IECEx	IEC 60079-0, -15
cFMus	FM 3600, 3611, 3810
	CSA E60079-0, -15
	CSA 22.2 -213
EMC 2004/108/EC	EN 61326-1
LVD 2006/95/EC	EN 61010-1:2001
UL, Standard for Safety	UL 61010-1
Safe Isolation	EN 61140

of span = of the currently selected measurement range

Display readout on the 4501 of sensor error detection and input signal outside range

Sensor error check:		
Device:	Configuration	Sensor error detection:
3114	OUT.ERR=NONE.	OFF
	Else:	ON

Outside range readout (IN.LO, IN.HI): If the valid range of the A/D converter or the polynomial is exceeded			
Input	Range	Readout	Limit
VOLT	0...1 V / 0.2...1 V	IN.LO	< -25 mV
		IN.HI	> 1.2 V
	0...10 V / 2...10 V	IN.LO	< -25 mV
		IN.HI	> 12 V
CURR	0...20 mA / 4...20 mA	IN.LO	< -1.05 mA
		IN.HI	> 25.05 mA
LIN.R	0...800 Ω	IN.LO	< -10 Ω
		IN.HI	> ca. 1075 Ω
	0...10 k Ω	IN.LO	< -10 Ω
		IN.HI	> 110 k Ω
POTM	0...100%	IN.LO	< -0.5 %
		IN.HI	> 100.5 %
TEMP	TC / Pt100	IN.LO	< temperature range -2°C
		IN.HI	> temperature range +2°C

Display readout below min.- / above max. (-1999, 9999):			
Input	Range	Readout	Limit
All	All	-1999	Display readout < -1999
		9999	Display readout > 9999

Sensor error detection limits

Sensor error detection (SE.BR, SE.SH):			
Input	Range	Readout	Limit
CURR	Loop break (4..20 mA)	SE.BR	<= 3.6 mA; > = 21 mA
POTM	All, SE.BR on all 3-wire	SE.BR	> ca. 126 k Ω
LIN.R	0...800 Ω	SE.BR	> ca. 875 Ω
	0...10 k Ω	SE.BR	> ca. 11 k Ω
TEMP	TC RTD, 2-, 3-, and 4-wire No SE.SH for Pt10, Pt20 and Pt50	SE.BR	> ca. 750 k Ω / (1.25 V)
		SE.BR	> ca. 15 k Ω
		SE.SH	< ca. 15 Ω

Error indications

Readout at hardware error		
Error search	Readout	Error cause
CJC sensor error - check device temperature	CJ.ER	Defect CJC sensor or CJC temperature out allowed range **
Flash memory error - default configuration is loaded	FL.ER	Error in FLASH (configuration)*
No communication	NO.CO	No communication
Input error - check input connection and reset power	IN.ER	Error levels on measurement inputs*
Programming mode only - no output signal	PROG.	Offline configuration mode (3114 powered by communications interface)***
Invalid configuration type or version	TY.ER	Configuration read from EEprom has invalid type or rev. no.
Hardware error	RA.ER	RAM memory error*
Hardware error	EE.ER	EEPROM memory error*
Hardware error	NO.CA	Device not factory-calibrated
Hardware error	AD.ER	A/D converter error*
Hardware error	EF.ER	External Flash error*
Hardware error	IF.ER	Internal Flash error*

! All error indications in the display flash once per second (1 Hz), and the corresponding help text is shown. If the error is a sensor error, the display backlight flashes as well - this is acknowledged (stopped) by pushing the OK button.

* Error is acknowledged by entering the menu and saving or by resetting the device power

** Error can be disregarded by selecting input type different than TC.

*** Error indication does not flash. Error is acknowledged by connecting device power.

CONNECTIONS

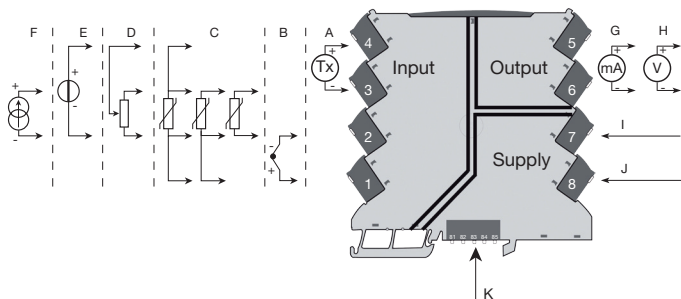

	Input signals
A	Current 1
B	TC
C	RTD
D	Potentiometer
E	Voltage
F	Current 2

	Output signals
G	Current
H	Voltage

	Supply
I	Supply +
J	Supply -
K	Power rail connections

INSTALLATION ON POWER RAIL

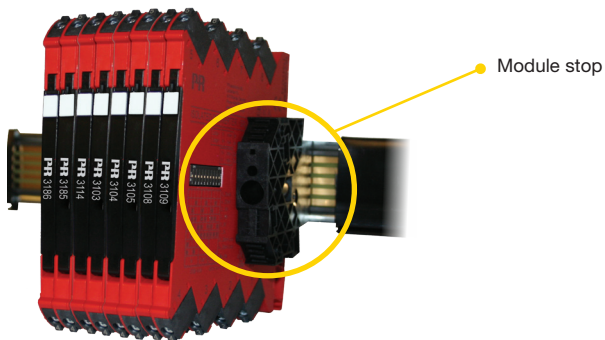

The 3114 can be installed on a power rail (PR part number 9400) supported, if necessary, by module stop for power rail (PR part number 9404). Power supply units can be mounted on the power rail according to customer requirements.

MARKING

The front cover of the 3114 series has been designed with an area for affixation of a click-on marker. The area assigned to the marker measures 5 x 7.5 mm. Markers from Weidmüller's MultiCard System, type MF 5/7.5, are suitable.

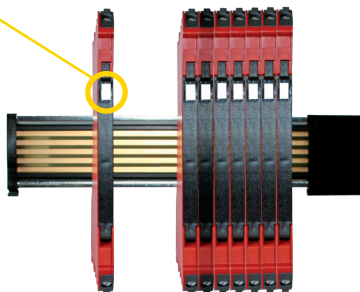

LED INDICATION



The device is equipped with a green power LED in the front to indicate the operation status, see the table below.

LED	Condition	Output and loop supply	Action required
OFF	No supply / device error or code-flash CRC error	De-energized	Connect supply / replace device
1 Flash (0.5 s OFF + 0.5 s ON)	Power-up or restart	De-energized	-
Flashing 13 Hz (15 ms ON)	Device OK	Energized	-
Flashing 1 Hz (15 ms ON)	Sensor error	De-energized	Correct setting and re-power device
Flashing 1 Hz (0.5 s ON)	Restarting due to: Supply error/hardware. RAM or program flow error	De-energized	Adjust supply / replace device

DEFAULT CONFIGURATION

Input

Input type	Temperature
Voltage input	0...10 V
Current input	4...20 mA
Sensor connection (RTD+resistance).....	3 wire
R input range.....	0...1000
Temperature unit	°C
Temperature type	Pt
Pt type	Pt100
Ni type	Ni100
TC type.....	K
Display unit.....	°C
Decimal point	000.0
Display low	0.0
Display high.....	100.0

Output

Output type	Current
Voltage output	0...10 V
Current output.....	4...20 mA
Analogue out on error	23 mA
Analogue out low	0
Analogue out high	150
Output limit.....	No

Advanced

LCD contrast	3
LCD backlight.....	4
TAG.....	TAG NO.
Line 3 function.....	Analogue out
Use calibration	No
Enable password protection	No
Calibration range.....	0.0 / 100.0
Calibration point.....	0.0 / 100.0
Language.....	UK

CONFIGURATION / OPERATING THE FUNCTION KEYS

Documentation for routing diagram.

In general

When configuring the 3114, you will be guided through all parameters and you can choose the settings which fit the application. For each menu there is a scrolling help text which is automatically shown in line 3 on the display.

Configuration is carried out by using the 3 function keys:

- ⬆ will increase the numerical value or choose the next parameter
- ⬇ will decrease the numerical value or choose the previous parameter
- OK will accept the chosen value and proceed to the next menu

When configuration is completed, the display will return to the default state 1.0.

Pressing and holding OK will return to the previous menu or return to the default state (1.0) without saving the changed values or parameters.

If no key is activated for 1 minute, the display will return to the default state (1.0) without saving the changed values or parameters.

Further explanations

Password protection: Programming access can be blocked by assigning a password. The password is saved in the transmitter in order to ensure a high degree of protection against unauthorised modifications to the configuration. Default password 2008 allows access to all configuration menus.

Signal and sensor error info via display front 4501

Sensor error (see limits in the table) is displayed as SE.BR (sensor break) or SE.SH (sensor short). Signals outside the selected range (not sensor error, see table for limits) are displayed as IN.LO indicating low input signal or IN.HI indicating high input signal. The error indication is displayed in line 3 as text and at the same time the backlight flashes. Line 4 of the display is a status line which displays COM (flashing bullet) indicating correct functioning of 4501, and arrow up/down which indicates tendency readout of the input signal.

Signal and sensor error indication without display front

Status of the unit can also be read from the green LED in the front of the device.

Green flashing LED 13 Hz indicates normal operation.

Green flashing LED 1 Hz indicates sensor error.

No light in the LED indicates internal error.

Advanced functions

The unit gives access to a number of advanced functions which can be reached by answering "Yes" to the point "adv.set".

Display setup: Here you can adjust the brightness contrast and the backlight. Setup of TAG number with 6 alphanumeric. Selection of functional readout in line 3 of the display - choose between readout of analogue output or TAG number.

Two-point process calibration: The unit can be process-calibrated in 2 points to fit a given input signal. A low input signal (not necessarily 0%) is applied and the actual value is entered via 4501. Then a high signal (not necessarily 100%) is applied and the actual value is entered via 4501. If you accept to use the calibration, the unit will work according to this new adjustment. If you later reject this menu point or choose another type of input signal the unit will return to factory calibration.

Process simulation function: If you say "yes" to the point "EN.SIM" it is possible to simulate an input signal by means of the arrow keys and thus control the output signal up or down. When you finalise the point with , the unit returns to normal mode.

Password: Here you can choose a password between 0000 and 9999 in order to protect the unit against unauthorised modifications to the configuration. The unit is delivered default without password. If you have locked the unit with a password by mistake, you can always open the menu by using the master password 2008.

Language: In the menu "lang.setup" you can choose between 7 different language versions of help texts that will appear in the menu. You can choose between UK, DE, FR, IT, ES, SE and DK.

Selection of units

After choosing the input signal type you can choose the process units which will be displayed in text line 2 (see table). By selection of temperature input the process value is always displayed in Celsius or Fahrenheit. This is selected in the menu point after selection of temperature input.

Memory

In the memory menu you can save the configuration of the device in the 4501, and then move the 4501 onto another device of the same type and download the configuration in the new device.

Power up

Hold \wedge and \vee :
Toggle Line 3 function
between A.Out / TAG.
(Setting is volatile - use DISP
setup menu to change and
store Line 3 function.)

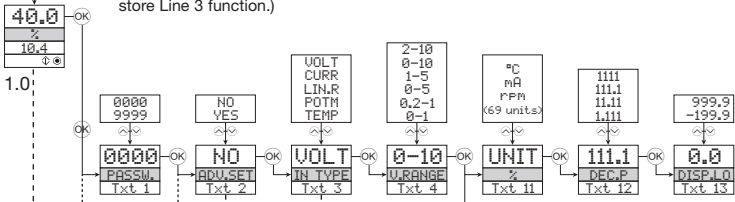

(No power)

- 1.1
- 1.0 = Default state
Line 1 shows input signal.
Line 2 shows UNIT.
By pressing \wedge and \vee simultaneously line 3 alternates between A.Out and TAG.
Line 4 shows communication status.
- 1.1 = The 4501 will power off if no key is activated for 1 minute.
- 1.2 = Only if password is enabled.
- 1.3 = Downscale to 0 mA / 3.5 mA or 0 V.
Upscale to 23 mA or 110% of Vout high.
Only if input type supports sensor error check.
Not valid for these input signals:
0...20 mA and voltage.
- 1.4 = Only if input signal is temperature.

Continued on the page
Routing diagram ADV.SET

ROUTING DIAGRAM

If no key is activated for 1 minute, the display will return to the default state 1.0 without saving configuration changes.

⬆ Increase value / choose next parameter

⬇ Decrease value / choose previous parameter

⊗ Accept the chosen value and proceed to the next menu

Hold ⊗ Back to previous menu / return to menu 1.0 without saving

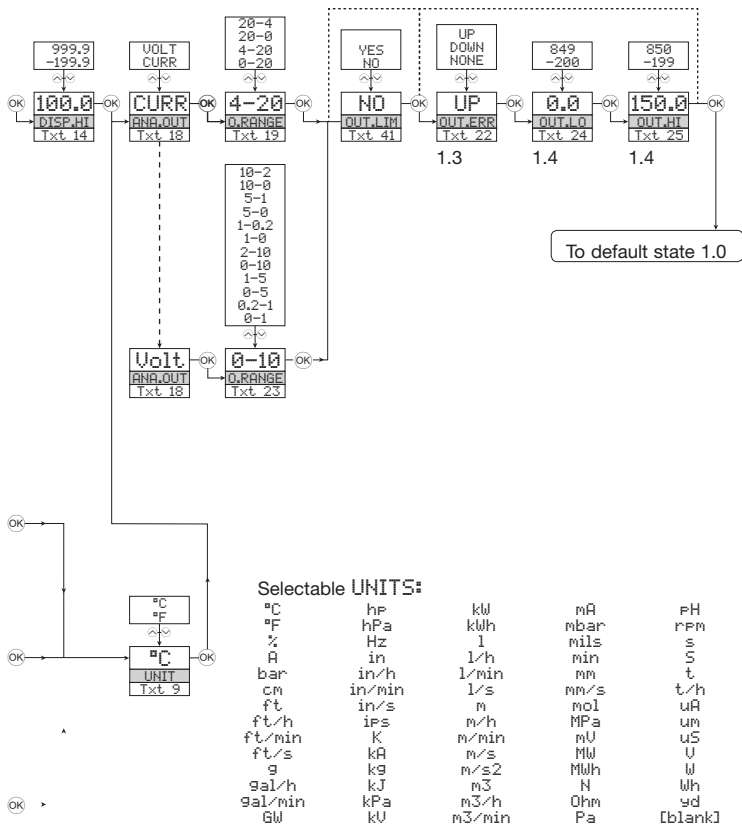

ROUTING DIAGRAM

ADVANCED SETTINGS (ADV.SET)

2.0 In the submenu simulation (SIM) you must press **⊗** to return to the default state 1.0.

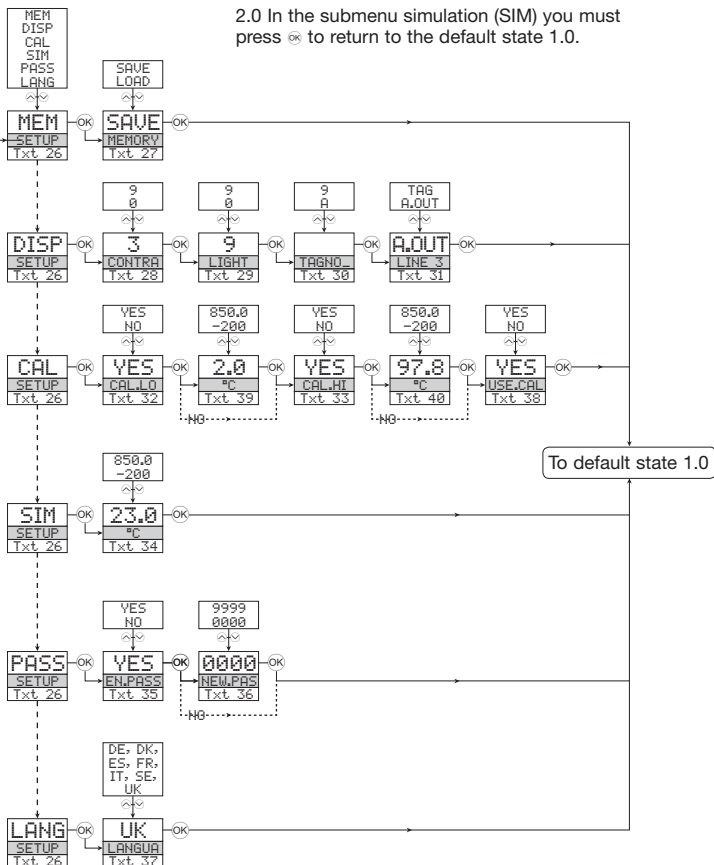

SCROLLING HELP TEXT IN DISPLAY LINE 3

- [01] Set correct password
- [02] Enter advanced setup menu?
- [03] Select temperature input
Select potentiometer input
Select linear resistance input
Select current input
Select voltage input
- [04] Select 0.0-1 V input range
Select 0.2-1 V input range
Select 0-5 V input range
Select 1-5 V input range
Select 0-10 V input range
Select 2-10 V input range
- [05] Select 0-20 mA input range
Select 4-20 mA input range
- [06] Select 2-wire sensor connection
Select 3-wire sensor connection
Select 4-wire sensor connection
- [07] Set resistance value low
- [08] Set resistance value high
- [09] Select Celsius as temperature unit
Select Fahrenheit as temperature unit
- [10] Select TC sensor type
Select Ni sensor type
Select Pt sensor type
- [11] Select display unit
- [12] Select decimal point position
- [13] Set display range low
- [14] Set display range high
- [15] Select Pt10 as sensor type
Select Pt20 as sensor type
Select Pt50 as sensor type
Select Pt100 as sensor type
Select Pt200 as sensor type
Select Pt250 as sensor type
Select Pt300 as sensor type
Select Pt400 as sensor type
Select Pt500 as sensor type
Select Pt1000 as sensor type
- [16] Select Ni50 as sensor type
Select Ni100 as sensor type
Select Ni120 as sensor type
Select Ni1000 as sensor type
- [17] Select TC-B as sensor type
Select TC-E as sensor type
Select TC-J as sensor type
Select TC-K as sensor type
Select TC-L as sensor type
Select TC-N as sensor type
Select TC-R as sensor type
Select TC-S as sensor type
Select TC-T as sensor type
Select TC-U as sensor type
Select TC-W3 as sensor type
Select TC-W5 as sensor type
Select TC-Lr as sensor type
- [18] Select current as analogue output type
Select voltage as analogue output type
- [19] Select 0-20 mA output range
Select 4-20 mA output range
Select 20-0 mA output range
Select 20-4 mA output range
- [22] Select no error action - output undefined at error
Select downscale at error
Select upscale at error
Select 0.0-1 V output range
- [23] Select 0.2-1 V output range
Select 0-5 V output range
Select 1-5 V output range
Select 0-10 V output range
Select 2-10 V output range
Select 1-0.0 V output range
Select 1-0.2 V output range
Select 5-0 V output range
Select 5-1 V output range
Select 10-0 V output range
Select 10-2 V output range
- [24] Set temperature for analogue output low
- [25] Set temperature for analogue output high
- [26] Enter language setup
Enter password setup
Enter simulation mode
Perform process calibration
Enter display setup
Perform memory operations
- [27] Load saved configuration into device
Save configuration in display front
- [28] Adjust LCD contrast
- [29] Adjust LCD backlight
- [30] Write a 6-character device TAG
- [31] Analogue output value is shown in display line 3
Device TAG is shown in display line 3
- [32] Calibrate input low to process value?
- [33] Calibrate input high to process value?
- [34] Set the input simulation value
- [35] Enable password protection?
- [36] Set new password
- [37] Select language
- [38] Use process calibration values?
- [39] Set value for low calibration point
- [40] Set value for high calibration point
- [41] Limit output values to output range)
- [42] Programming mode only - no output signal



Displays Programmable displays with a wide selection of inputs and outputs for display of temperature, volume and weight, etc. Feature linearisation, scaling, and difference measurement functions for programming via PReset software.



Ex interfaces Interfaces for analogue and digital signals as well as HART® signals between sensors / I/P converters / frequency signals and control systems in Ex zone 0, 1 & 2 and for some modules in zone 20, 21 & 22.



Isolation Galvanic isolators for analogue and digital signals as well as HART® signals. A wide product range with both loop-powered and universal isolators featuring linearisation, inversion, and scaling of output signals.























Temperature A wide selection of transmitters for DIN form B mounting and DIN rail modules with analogue and digital bus communication ranging from application-specific to universal transmitters.



Universal PC or front programmable modules with universal options for input, output and supply. This range offers a number of advanced features such as process calibration, linearisation and auto-diagnosis.



- 
 www.preelectronics.fr
 sales@preelectronics.fr
- 
 www.preelectronics.de
 sales@preelectronics.de
- 
 www.preelectronics.es
 sales@preelectronics.es
- 
 www.preelectronics.it
 sales@preelectronics.it
- 
 www.preelectronics.se
 sales@preelectronics.se
- 
 www.preelectronics.com
 sales@preelectronics.com
- 
 www.preelectronics.com
 sales@preelectronics.com

Head office

Denmark
 PR electronics A/S
 Lerbakken 10
 DK-8410 Rønde

www.preelectronics.com
sales@preelectronics.dk
 tel. +45 86 37 26 77
 fax +45 86 37 30 85



QUALITY SYSTEM AND ENVIRONMENTAL MANAGEMENT SYSTEM
 DS/EN ISO 9001
 DS/EN ISO 14001

