

**P4R**  
electronics



**9410**

**Power Control Unit**

No. 9410V102-UK

Product version: 9410-001



**ATEX**



Segurança  
**N**  
INMETRO



- DK** ▶ PR electronics A/S tilbyder et bredt program af analoge og digitale signalbehandlingsmoduler til industriel automation. Programmet består af Isolatorer, Displays, Ex-barrierer, Temperaturtransmittere, Universaltransmittere mfl. Vi har modulerne, du kan stole på i selv barske miljøer med elektrisk støj, vibrationer og temperaturudsving, og alle produkter opfylder de strengeste internationale standarder. Vores motto »Signals the Best« er indbegrebet af denne filosofi - og din garanti for kvalitet.
- UK** ▶ PR electronics A/S offers a wide range of analog and digital signal conditioning devices for industrial automation. The product range includes Isolators, Displays, Ex Interfaces, Temperature Transmitters, and Universal Devices. You can trust our products in the most extreme environments with electrical noise, vibrations and temperature fluctuations, and all products comply with the most exacting international standards. »Signals the Best« is the epitome of our philosophy - and your guarantee for quality.
- FR** ▶ PR electronics A/S offre une large gamme de produits pour le traitement des signaux analogiques et numériques dans tous les domaines industriels. La gamme de produits s'étend des transmetteurs de température aux afficheurs, des isolateurs aux interfaces SI, jusqu'aux modules universels. Vous pouvez compter sur nos produits même dans les conditions d'utilisation sévères, p.ex. bruit électrique, vibrations et fluctuations de température. Tous nos produits sont conformes aux normes internationales les plus strictes. Notre devise »SIGNALS the BEST« c'est notre ligne de conduite - et pour vous l'assurance de la meilleure qualité.
- DE** ▶ PR electronics A/S verfügt über ein breites Produktprogramm an analogen und digitalen Signalverarbeitungsgeräte für die industrielle Automatisierung. Dieses Programm umfasst Displays, Temperaturtransmitter, Ex- und galvanische Signaltrenner, und Universalgeräte. Sie können unsere Geräte auch unter extremen Einsatzbedingungen wie elektrisches Rauschen, Erschütterungen und Temperaturschwingungen vertrauen, und alle Produkte von PR electronics werden in Übereinstimmung mit den strengsten internationalen Normen produziert. »Signals the Best« ist Ihre Garantie für Qualität!

# POWER CONTROL UNIT

## 9410

### CONTENTS

Warning.....	2
Symbol identification .....	2
Safety instructions.....	2
How to dismantle system 9000.....	4
Application and advanced features.....	5
Technical characteristics.....	5
Order .....	7
Electrical specifications.....	7
Connections .....	9
Block diagram.....	10
Appendix .....	11
IECEX Installation Drawing.....	12
ATEX Installation Drawing .....	15
FM Installation Drawing.....	18
INMETRO Installation Drawing.....	21



## WARNING

The following operations should only be carried out on a disconnected device and under ESD-safe conditions:

- General mounting, connection and disconnection of wires.
- Troubleshooting the device.

**Repair of the device and replacement of circuit breakers must be done by PR electronics A/S only.**

## SYMBOL IDENTIFICATION

Triangle with an exclamation mark: Read the manual before installation and commissioning of the device in order to avoid incidents that could lead to personal injury or mechanical damage.



The CE mark proves the compliance of the device with the essential requirements of the directives.



**The double insulation symbol** shows that the device is protected by double or reinforced insulation.



Ex devices have been approved according to the ATEX directive for use in connection with installations in explosive areas.



## SAFETY INSTRUCTIONS

### DEFINITIONS:

**Hazardous voltages** have been defined as the ranges: 75...1500 Volt DC, and 50...1000 Volt AC.

**Technicians** are qualified persons educated or trained to mount, operate, and also troubleshoot technically correct and in accordance with safety regulations.

**Operators**, being familiar with the contents of this manual, adjust and operate the knobs or potentiometers during normal operation.

### RECEIPT AND UNPACKING:

Unpack the device without damaging it and check whether the device type corresponds to the one ordered. The packing should always follow the device until this has been permanently mounted.

**ENVIRONMENT:**

Avoid direct sunlight, dust, high temperatures, mechanical vibrations and shock, as well as rain and heavy moisture. If necessary, heating in excess of the stated limits for ambient temperatures should be avoided by way of ventilation.

The device must be installed in pollution degree 2 or better.

The device is designed to be safe at least under an altitude up to 2 000 m.

**MOUNTING:**

Only technicians who are familiar with the technical terms, warnings, and instructions in the manual and who are able to follow these should connect the device.

Should there be any doubt as to the correct handling of the device, please contact your local distributor or, alternatively,

**PR electronics A/S**  
**[www.prelectronics.com](http://www.prelectronics.com)**

Mounting and connection of the device should comply with national legislation for mounting of electric materials, i.a. wire cross section, protective fuse, and location.

The use of stranded wires is not permitted for mains wiring except when wires are fitted with cable ends.

Descriptions of input / output and supply connections are shown in the block diagram and on the side label.

The device is provided with field wiring terminals and shall be supplied from a Power Supply having double / reinforced insulation. A power switch shall be easily accessible and close to the device. The power switch shall be marked as the disconnecting device for the device.

Year of manufacture can be taken from the first two digits in the serial number.

**CALIBRATION AND ADJUSTMENT:**

During calibration and adjustment, the measuring and connection of external voltages must be carried out according to the specifications of this manual. The technician must use tools and instruments that are safe to use.

**NORMAL OPERATION:**

Operators are only allowed to adjust and operate devices that are safely fixed in panels, etc., thus avoiding the danger of personal injury and damage. This means there is no electrical shock hazard, and the device is easily accessible.

**CLEANING:**

When disconnected, the device may be cleaned with a cloth moistened with distilled water.

**LIABILITY:**

To the extent the instructions in this manual are not strictly observed, the customer cannot advance a demand against PR electronics A/S that would otherwise exist according to the concluded sales agreement.

## HOW TO DISMANTLE SYSTEM 9000

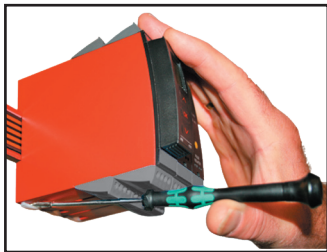

**Picture 1:**

By lifting the bottom lock, the device is detached from the DIN rail.

# POWER CONTROL UNIT

## 9410

- *Distributes supply voltage to the power rail*
- *Optional connection of backup supply*
- *Approved for installation in Ex zone 2 / Div. 2*
- *Optional redundant supply for the power rail*
- *Must be installed on power rail, PR type 9400*

### Application and advanced features

- The power control unit detects errors from any of the devices mounted on the power rail and transmits a collective alarm to the control system via the internal status relay.
- Optional connection of two power supplies - a primary supply and a backup supply.
- Redundant supply for the power rail can be obtained by mounting two 9410 devices connected to 2 separate power supplies (e.g. PR 9420).

### Technical characteristics

- The status relay will be energised (pins 11 & 12) when the following three conditions are met:
  1. Supply voltage is present on pins 31 and 32.
  2. Backup supply voltage is present on pins 34 and 33. (If the backup supply is not in use, a jumper must be placed between pins 32 and 33 - the jumper is delivered with the device).
  3. There are no error signals from the devices connected to the power rail.
- When a collective alarm is activated via the power rail, the status relay in the 9410 will be de-energised (pins 13 & 12).
- Two green front LEDs indicate connection of supply and backup.
- A red LED indicates error status.

# Applications

## Device status relay from power rail

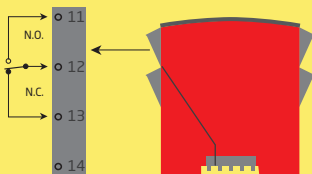

## Power connection

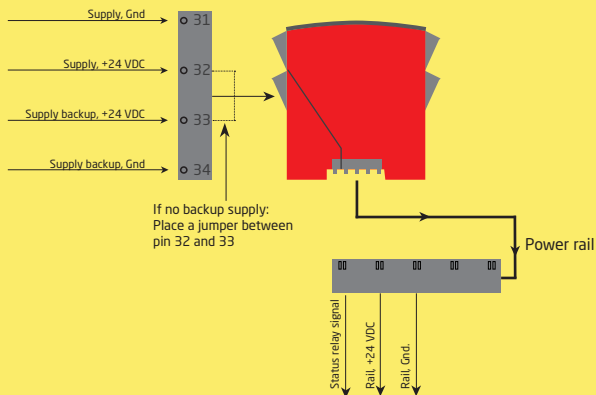

Zone 2 / FM Cl. 1, div. 2 or safe area



# ORDER

## 9410 = Power Control Unit

### Electrical specifications

#### Environmental conditions

Specifications range .....	-20...+60°C
Storage temperature .....	-20...+85°C
Relative humidity .....	< 95% RH (non-cond.)
Protection degree .....	IP20
Installation in .....	Pollution degree 2 & measurement / overvoltage category II

#### Mechanical specifications:

Dimensions (HxBxD) .....	109 x 23.5 x 104 mm
Weight .....	140 g
Wire size (min. / max.) .....	0.13...2.08 mm <sup>2</sup> / AWG 26...14 stranded wire
Screw terminal torque .....	0.5 Nm
Vibration .....	IEC 60068-2-6 : 2007
2...13.2 Hz .....	±1 mm
13.2...100 Hz .....	±0.7

#### Common specifications:

Max. consumption .....	96 W
Efficiency .....	> 97,9%
Max. internal consumption .....	2 W

#### Input:

Supply voltage, double / reinforced isolation .....	21.6...26.4 VDC
Backup supply .....	21.6...26.4 VDC
Trig levels for voltage surveillance .....	Error < 21 VDC

#### Output:

Output voltage @ 4 A .....	Input voltage - 0.5 VDC
Output power, max. ....	96 W
Output current, max. ....	4 A
Output ripple .....	Samme as input ripple

**Status relay in safe area:**

Max. voltage .....	250 VAC / 30 VDC
Max. current.....	2 AAC / 2 ADC
Max. AC power .....	500 VA / 60 W

**Approvals:**

EMC 2004/108/EC .....	EN 61326-1
LVD 2006/95/EC.....	EN 61010-1
c UL us, Standard for Safety.....	UL 61010-1
EAC TR-CU 020/2011.....	EN 61326-1
Metrological Pattern Approval.....	DK.C.34.004.A No. 47954

**Marine:**

Det Norske Veritas, Ships & Offshore .....	Stand. f. Certific. No. 2.4
--	-----------------------------

**I.S. / Ex:**

ATEX 94/9/EC.....	KEMA 07ATEX0152 X
IECEX .....	IECEX KEM 08.0025X
c FM us.....	3034431-C
INMETRO .....	NCC 12.1308 X

# CONNECTIONS

## Inputs:

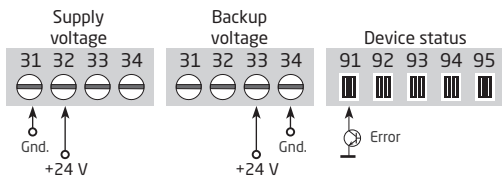

If no backup supply:  
Place a jumper between  
pin 32 and 33

## Outputs:

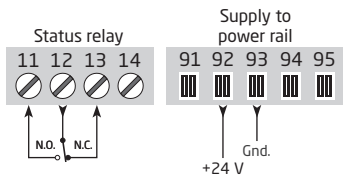

# BLOCK DIAGRAM

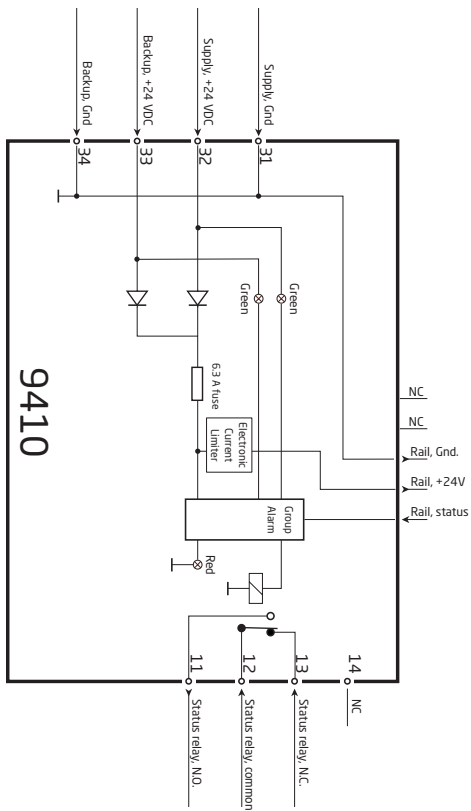

NC = No Connection

# APPENDIX

**IECEX Installation drawing**  
**ATEX Installation drawing**  
**FM Installation drawing**  
**INMETRO Installation drawing**

## IECEX Installation drawing



### 9410

For safe installation of 9410 the following must be observed. The module shall only be installed by qualified personnel who are familiar with the national and international laws, directives and standards that apply to this area.

Year of manufacture can be taken from the first two digits in the serial number.

### 9410 Power Control Unit

IECEX Certificate	IECEX KEM 08.0025 X
Marking:	Ex nA nC IIC T4 Gc
Standards:	IEC60079-0:2011, IEC60079-15:2010

Non Hazardous Area or Zone 2

T4: -20 °C <Ta < +60°C

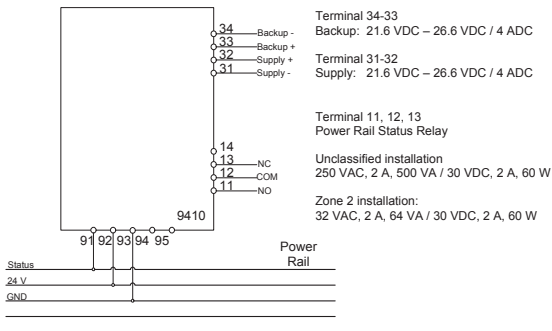

**9410 Power Control with backup.**



Use Endcaps to prevent the Power Rail from being short circuit by the outer enclosure.

Use 9400 Cover to prevent open Power Rail from unintentional short circuit.

**Redundant 9410 Power Control with Backup.**

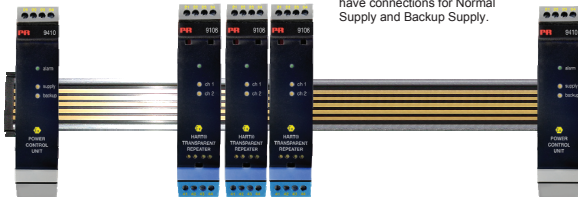

Power is supplied to the Power Rail from two 9410 Power Control Modules. Both modules have connections for Normal Supply and Backup Supply.

**Installation notes:****General**

The 9410 must be supplied from a Power Source with Double or Reinforced insulation to Mains.

## Terminal blocks :

Wire size

0.13-2.08 mm<sup>2</sup> / AWG 26-14 stranded wire

Screw terminal torque

0.5 Nm

**For installation in Zone 2**

The 9410 Power Control Unit and 9400 Power Rail must be installed in an outer enclosure having an IP protection of at least IP54, conforming to the requirements of explosion protection Ex-n or Ex-e.

Transients are suppressed by an internal transient protection device, which is set to a level not exceeding 40% of the rated voltage.

**WARNING:** Do not separate connectors when energized and an explosive gas mixture is present.

**WARNING:** Do not install or remove modules from the Power Rail unless Area is known to be Non Hazardous.

**WARNING:** Terminals 91,92,93,94,95 may only be connected to Power Rail 9400.



## ATEX Installation drawing

**9410**

For safe installation of 9410 the following must be observed. The module shall only be installed by qualified personnel who are familiar with the national and international laws, directives and standards that apply to this area.

Year of manufacture can be taken from the first two digits in the serial number.

**9410 Power Control Unit**

ATEX Certificate	KEMA 07ATEX0152X
Marking:	II 3G Ex nA nC IIC T4 Gc
Standard:	EN60079-0:2012, EN60079-15:2010

Non Hazardous Area or Zone 2

T4: -20 °C <Ta < +60°C

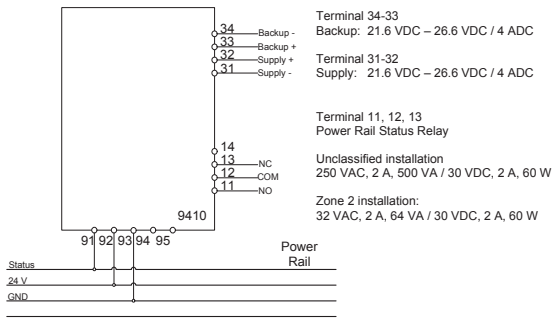

**9410 Power Control with backup**



Use Endcaps to prevent the Power Rail from being short circuit by the outer enclosure.

Use 9400 Cover to prevent open Power Rail from unintentional short circuit.

**Redundant 9410 Power Control with Backup**

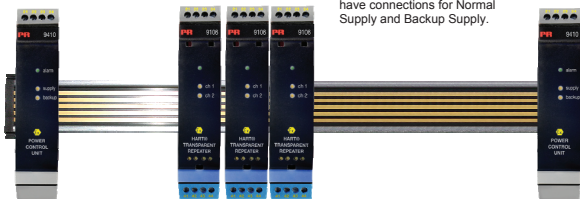

Power is supplied to the Power Rail from two 9410 Power Control Modules. Both modules have connections for Normal Supply and Backup Supply.

**9420 Power Supply and 9410 Power Control with Backup**

Maintain a minimum distance of 50 mm between the 9420 Power Supply and other modules.

**General**

The 9410 must be supplied from a Power Source with Double or Reinforced insulation to Mains.

Alternatively use PR9420 Power Supply for installation inside or outside Zone2.

**Terminal blocks:**

Wire size	0.13-2.08 mm <sup>2</sup> / AWG 26-14 stranded wire
Screw terminal torque	0.5 Nm

**For installation in Zone 2**

The 9410 Power Control Unit and 9400 Power Rail must be installed in an outer enclosure having an IP protection of at least IP54 conforming to the requirements of explosion protection Ex-n or Ex-e.

Transients are suppressed by an internal transient protection device, which is set to a level not exceeding 40% of the rated voltage.

**WARNING:** Do not separate connectors when energized and an explosive gas mixture is present.

**WARNING:** Do not install or remove modules from the Power Rail unless Area is known to be Non Hazardous.

## FM Installation drawing

**9410 Power Control Unit**

For safe installation of 9410 the following must be observed. The module shall only be installed by qualified personnel who are familiar with the national and international laws, directives and standards that apply to this area.

c-FM-us Certificate 3034431

Marking NI, Class I, Division 2, Group A,B,C,D T4 or  
Class I, Zone2, AEx nA nC IIC T4  
Class I, Zone2, Ex nA nC IIC T4

Standard: Class 3600, Class 3611, Class 3810, ANSI/ISA 12.00.01 / 12.12.02  
ISA 60079-15:2002, CSA-E79-15, CSA-C22.2-213

Non Hazardous Area or Division 2 / Zone 2

T4:  $-20\text{ }^{\circ}\text{C} < T_a < +60\text{ }^{\circ}\text{C}$

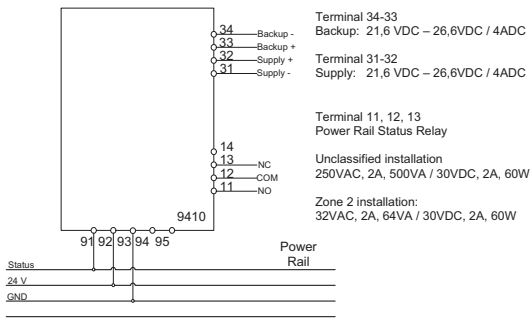

LERBAKKEN 10, 8410 RØNDE DENMARK

**9410 Power Control with backup.**



Use Endcaps to prevent the Power Rail from being short circuit by the outer enclosure.

Use 9400 Cover to prevent open Power Rail from unintentional short circuit.

**Redundant 9410 Power Control with Backup.**

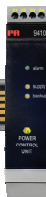

Power is supplied to the Power Rail from two 9410 Power Control Modules. Both modules have connections for Normal Supply and Backup Supply.

---

LERBAKKEN 10, 8410 RØNDE DENMARK

**Installation notes:**

The installation and wiring shall be in accordance with the Canadian Electrical Code for Canada and National Electrical Code NFPA 70, Article 500 or 505 for installation in USA.

The module must be supplied from a Power Supply having double or reinforced insulation.

The use of stranded wires is not permitted for mains wiring except when wires are fitted with cable ends.

For installation in Zone 2 or Division 2, the module must be installed in a suitable outer enclosure according to the regulations in the CEC for Canada or NEC for USA.

Install in pollution degree 2 or better.

Substitution of components may impair the suitability for division 2 / zone 2 installation.

**Warning:** To prevent ignition of the explosive atmospheres, disconnect power before servicing and do not separate connectors when energized and an explosive gas mixture is present.

**WARNING:** Do not install or remove modules from the Power Rail and do not remove connectors from the module unless Area is known to be Non Hazardous.

## INMETRO Desenhos para Instalação



### 9410

Para instalação segura do 9410 o manual seguinte deve ser observado. O módulo deve ser instalado somente por profissionais qualificados que estão familiarizados com as leis nacionais e internacionais, diretrizes e normas que se aplicam a esta área.

Ano de fabricação pode ser obtido a partir dos dois primeiros dígitos do número de série.

### 9410 Unidade de Controle de Potência

**INMETRO Certificado ..... NCC 12.1308X**

Marcas: Ex nA nC IIC T4 Gc

Normas IEC60079-0:2011, IEC60079-15:2005

Area de não Risco Area ou Zone 2

T4: -20 °C <Ta < +60°C

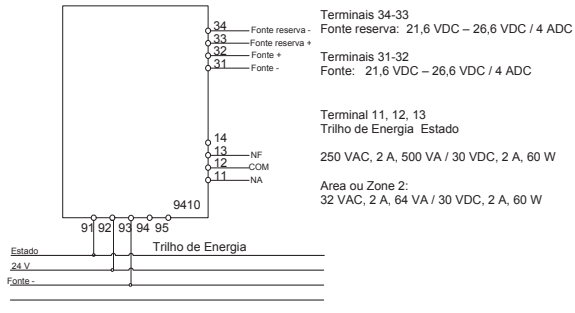

LERBAKKEN 10, 8410 RØNDE DENMARK

**9410 Controle de Potência com reserva.**

Use Tampas para evitar que o trilho de alimentação entre em curto-circuito com invólucro externo.



Use a capa do 9400 para prevenir que a abertura do trilho de energia e causar curto-circuito não intencional

A energia é fornecida ao barramento de alimentação de dois módulos de controle de energia 9410. Ambos os módulos têm conexões para a fonte de alimentação normal e a fonte reserva.

**Controle de Potencia 9410 redundante com reserva**





LERBAKKEN 10, 8410 RØNDE DENMARK

**Notas para Instalação:****Geral**

O 9410 deve ser energizado por uma fonte de alimentação com isolamento duplo ou reforçado vindo da rede elétrica.

**Para instalação em Zona 2**

O equipamento deve ser instalado dentro de um invólucro certificado conforme as normas da série ABNT NBR IEC 60079 que forneça no mínimo grau de proteção IP54.

Transientes são suprimidos por um dispositivo interno, que é definido para um nível não superior a 40% da tensão nominal.

**AVISO:** Não separe conectores quando energizado e uma mistura explosiva de gás estiver presente.

**AVISO:** Não instalar ou remover os módulos do trilho de energia a menos que área seja conhecida como não perigoso (não risco).

**AVISO:** Terminais 91, 92, 93, 94 e 95 só podem ser conectados ao Trilho de Energia 9400.



**Displays** Programmable displays with a wide selection of inputs and outputs for display of temperature, volume and weight, etc. Feature linearization, scaling, and difference measurement functions for programming via PReset software.



**Ex interfaces** Interfaces for analog and digital signals as well as HART® signals between sensors / I/P converters / frequency signals and control systems in Ex zone 0, 1 & 2 and for some devices in zone 20, 21 & 22.



**Isolation** Galvanic isolators for analog and digital signals as well as HART® signals. A wide product range with both loop-powered and universal isolators featuring linearization, inversion, and scaling of output signals.





























**Temperature** A wide selection of transmitters for DIN form B mounting and DIN rail devices with analog and digital bus communication ranging from application-specific to universal transmitters.



**Universal** PC or front programmable devices with universal options for input, output and supply. This range offers a number of advanced features such as process calibration, linearization and auto-diagnosis.



- 

[www.preelectronics.fr](http://www.preelectronics.fr)  

[sales-fr@preelectronics.com](mailto:sales-fr@preelectronics.com)
- 

[www.preelectronics.de](http://www.preelectronics.de)  

[sales-de@preelectronics.com](mailto:sales-de@preelectronics.com)
- 

[www.preelectronics.es](http://www.preelectronics.es)  

[sales-es@preelectronics.com](mailto:sales-es@preelectronics.com)
- 

[www.preelectronics.it](http://www.preelectronics.it)  

[sales-it@preelectronics.com](mailto:sales-it@preelectronics.com)
- 

[www.preelectronics.se](http://www.preelectronics.se)  

[sales-se@preelectronics.com](mailto:sales-se@preelectronics.com)
- 

[www.preelectronics.com](http://www.preelectronics.com)  

[sales-uk@preelectronics.com](mailto:sales-uk@preelectronics.com)
- 

[www.preelectronics.com](http://www.preelectronics.com)  

[sales-us@preelectronics.com](mailto:sales-us@preelectronics.com)
- 

[www.preelectronics.cn](http://www.preelectronics.cn)  

[sales-cn@preelectronics.com](mailto:sales-cn@preelectronics.com)
- 

[www.preelectronics.be](http://www.preelectronics.be)  

[sales-be@preelectronics.com](mailto:sales-be@preelectronics.com)

### Head office

Denmark  
 PR electronics A/S  
 Lerbakken 10  
 DK-8410 Rønde

[www.preelectronics.com](http://www.preelectronics.com)  
[sales-dk@preelectronics.com](mailto:sales-dk@preelectronics.com)  
 tel. +45 86 37 26 77  
 fax +45 86 37 30 85



QUALITY SYSTEM AND ENVIRONMENTAL MANAGEMENT SYSTEM  
 DS/EN ISO 9001  
 DS/EN ISO 14001

