



Linear transducer with wire potentiometer technology.

Excellent repeatability, high IP rating, resistance to shock and vibrations, and high electromagnetic compatibility make this transducer suitable for mobile hydraulic applications.

Developed to guarantee a robust, high-performance solution for applications such as agricultural vehicles, earth-moving machines, and hoisting equipment.

TECHNICAL SPECIFICATIONS

Measurement Range

Stroke 1.800mm - 2.300mm - 3.300mm - 4.300mm - 4.800mm - 5.300mm - 6.300mm - 7.300mm - 8.000mm - 8.300mm
(for lower or middle strokes please refer to the dedicated ZERO/SPAN manual)

Supply voltage

+10..30 Vdc (potentiometric - voltage divider- output)
+10..36 Vdc (other output - see output signal for right supply voltage)

Output signal

Potentiometric - voltage divider- output; 0.5...4.5V; 0...10V; 4...20mA; CANopen output

Electrical connections

M12 connector output

Resolution

Virtually infinite for potentiometric - voltage divider- output; analog output 0.5...4.5V, 0...10V, 4...20mA 12 bit; CANopen output 14 bit

Linearity

± 0.25% FS (1800mm to 4300mm); ± 0.5% FS (4800mm to 8300mm).

Repeatability

± 0.1% FS

Working temperature

-40°C...+85°C

Vibrations

20g between 10 Hz ... 2000 Hz according to IEC 60068-2-6

Shock

Pulse on 3 axes; 50g 11 ms according to IEC 60068-2-27

Electromagnetic compatibility

2014/30/EU Electromagnetic Compatibility (EMC)

Life

250,000 cycles (strokes up to 5300 mm), otherwise 2000 km routes; typical speed 1m/s, typical acceleration 1g

IP Protection Level

IP67 with female mating connector (see accessories)

Constructive material of transducer body and wire

Transducer: PBT

Wire: AISI316 stainless steel, Ø0.85mm nylon coating

MECHANICAL DIMENSIONS

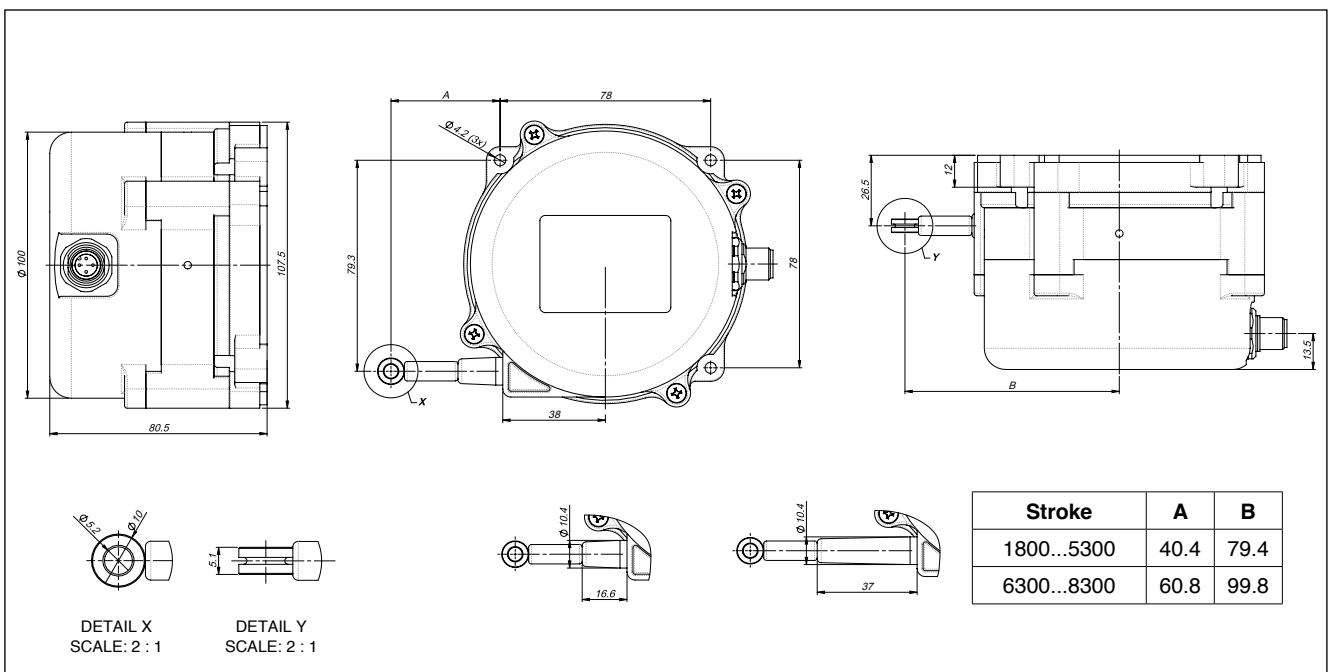

ELECTRICAL CONNECTIONS

SINGLE VERSION

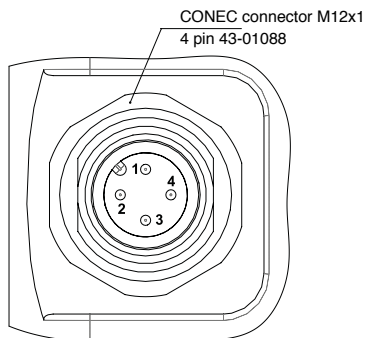

CONNECTIONS

1. +SUPPLY
2. GROUND
3. OUTPUT
4. n.c.

CANOpen CONNECTIONS

1. +SUPPLY
2. GROUND
3. CANH
4. CANL

REDUNDANT VERSION

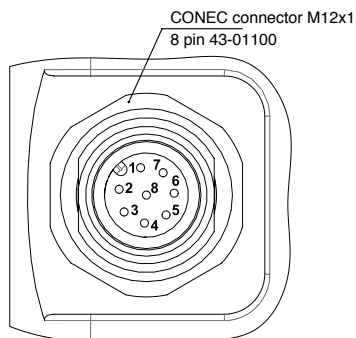

CONNECTIONS

1. + SUPPLY
2. GROUND
3. OUTPUT 1
4. n.c.
5. + SUPPLY
6. GROUND
7. OUTPUT 2
8. n.c.

CANOpen CONNECTIONS

1. + SUPPLY
2. GROUND
3. CANH 1
4. CANL 1
5. + SUPPLY
6. GROUND
7. CANH 2
8. CANL 2

ITEMS MARKED "n.c." SHOULD NOT BE CONNECTED

HOW TO CHANGE THE DIRECTION OF THE CONNECTOR

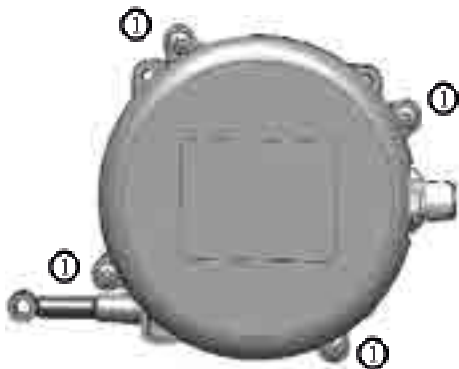

- 1 Carefully remove the 4 fixing screws from the closing cover shown in point ①.
- 2 Rotate the closing cover to the required position (4 possible configurations) ②.



Attention!! When closing the cover, be careful not to twist and/or crush the connector wires.

Possible configurations for the connector output ②

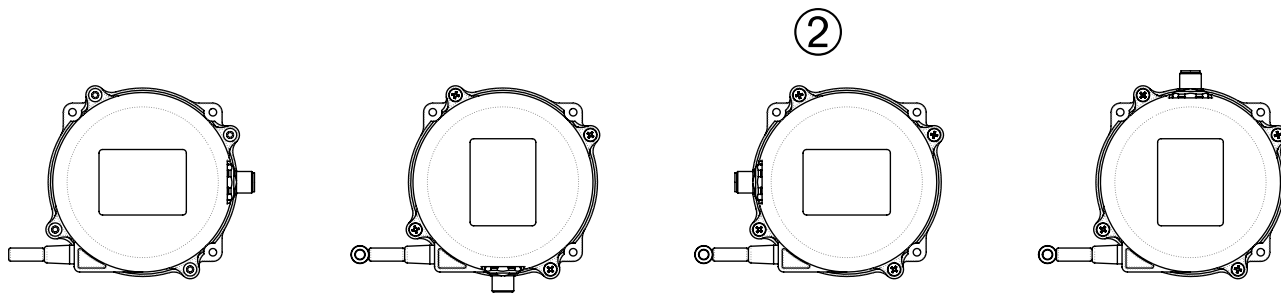

FIXING FLANGES (optional accessories to order)

FIXING FLANGE MODEL A - FLA033 (optional)

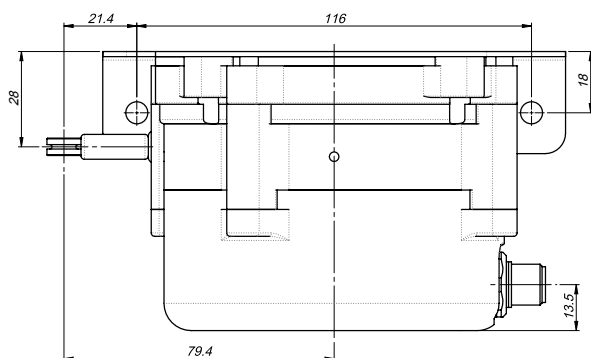
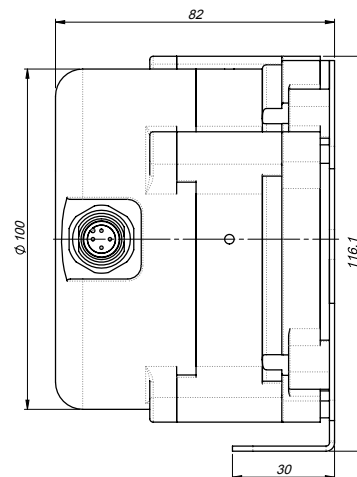
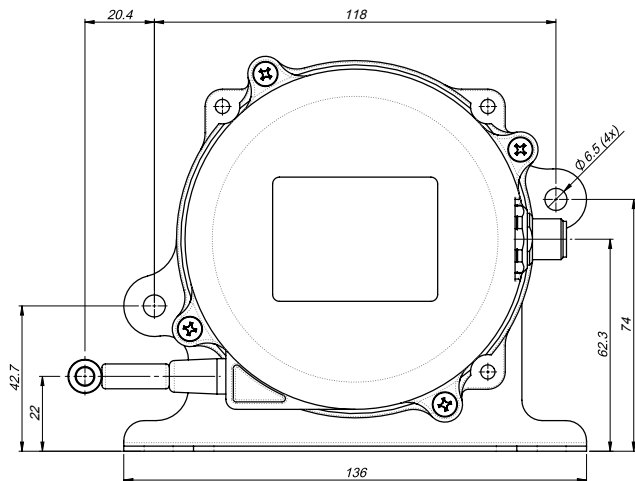

If the sensor is installed with a flange (A or B version) is it possible to modify the measurement wire output following these steps

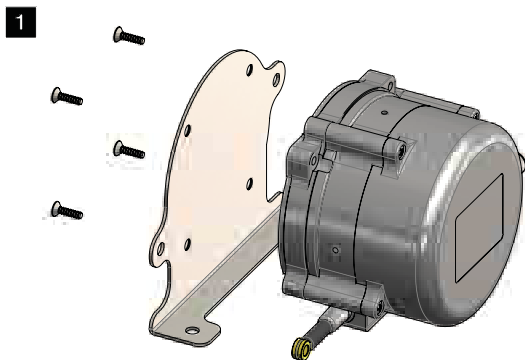

- 1 Carefully remove the 4 fixing screws from the flange shown in point 1.
- 2 Rotate the sensor to the required position: possible configurations are indicated at point 2.

Possible configurations 2

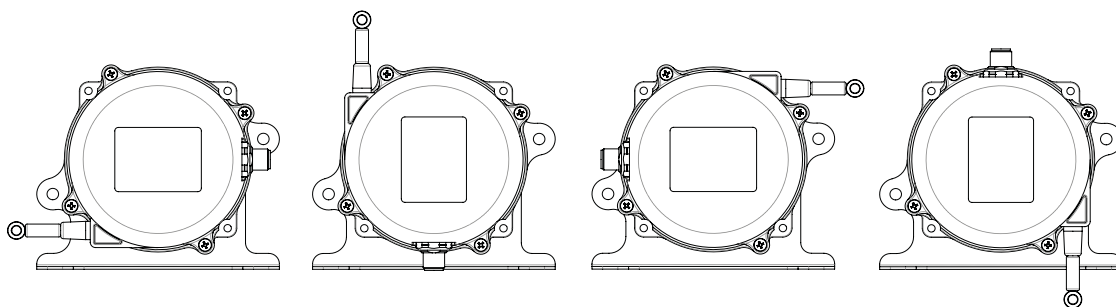

FIXING FLANGES (optional accessories to order)

ATTENTION!!!

For safety reasons, never screw off the 8 screws of the rear body shown in the drawing with the "X"

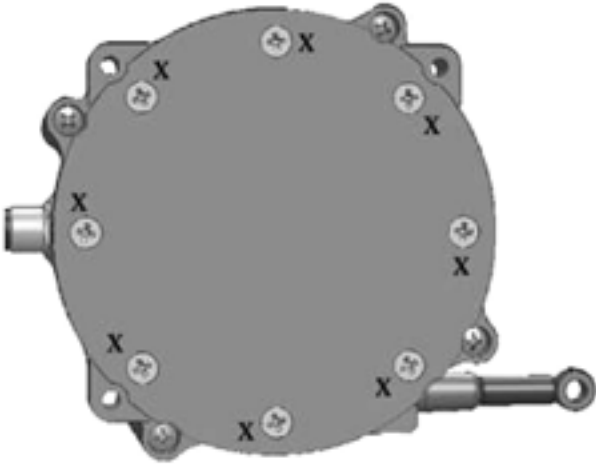

FIXING FLANGE MODEL B - FLA034 (optional)

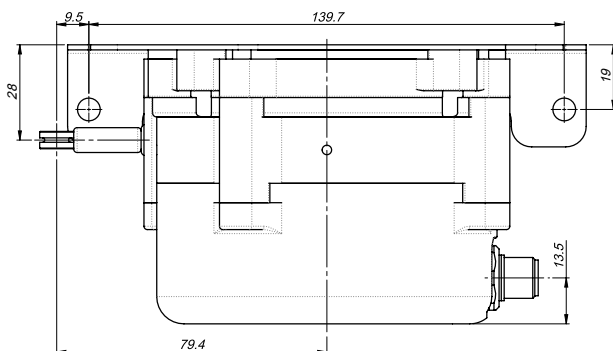
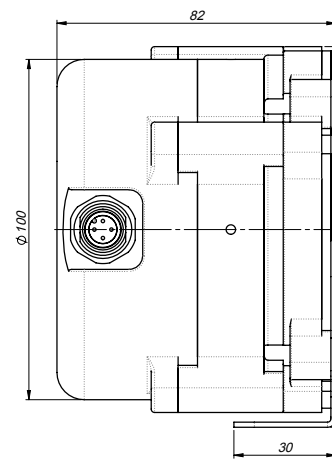
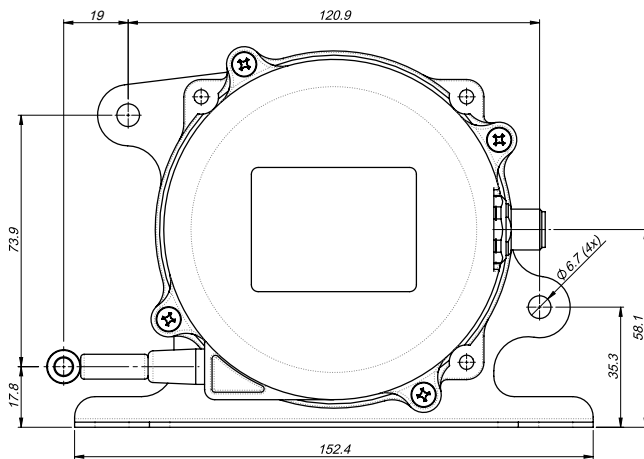

OPERATING SPECIFICATIONS: OUTPUT SIGNAL GRAPHS

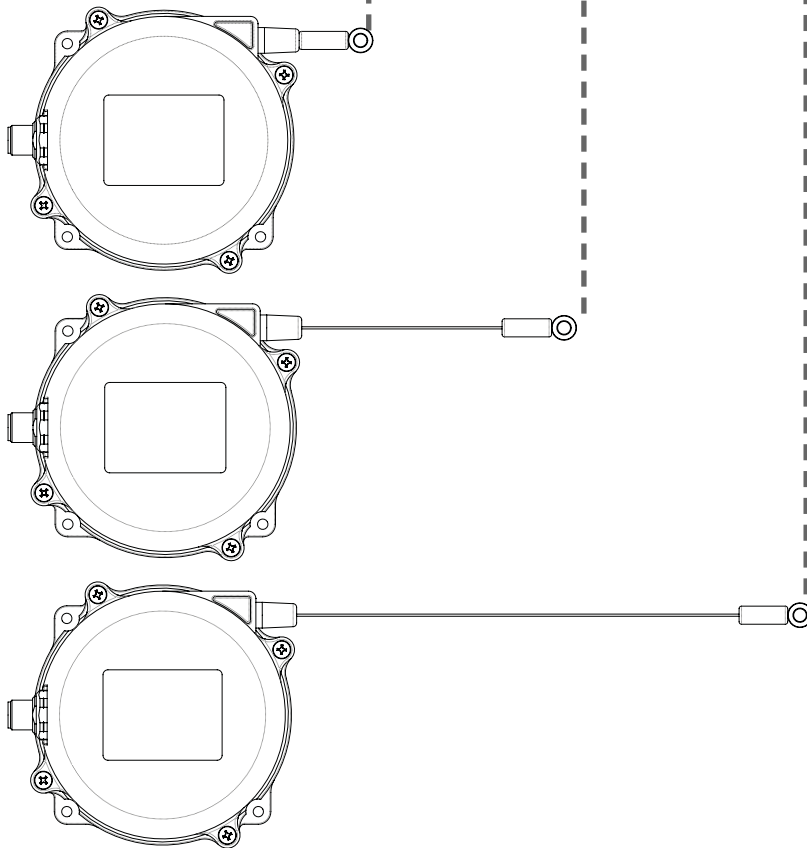
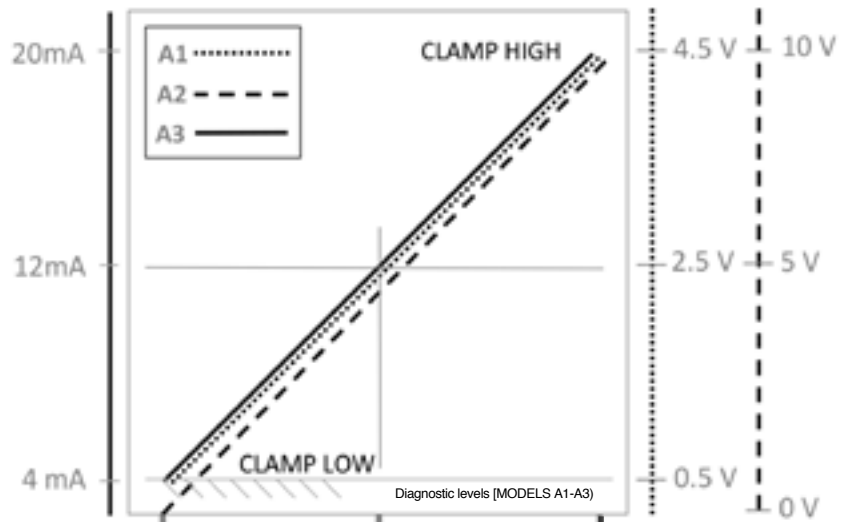

LOAD CONDITIONS

+0.5Vdc...+4.5Vdc output (powered at +10..36VDC) and 0..10VDC output (powered at +11..36VDC) : apply a load resistance >100Kohm

+0.5Vdc...+4.5Vdc output (powered at +5VDC): apply a load resistance > 10Kohm

4..20mA output (powered at < + 15..36VDC): maximum allowed load resistance is 200 ohm

4..20mA output (powered at > + 15..36VDC): maximum allowed load resistance is 500 ohm

ORDERING CODE

GSF - WIRE POTENTIOMETER TRANSDUCER

TRANSDUCER TYPE	
Wire transducer	S

ELECTRICAL CONNECTIONS	
M12 connector output	M

CIRCUIT TYPE	
Single	S
Redundant	R

MEASUREMENT RANGE	
measurement range (specify) available stroke: 1.800mm-2.300mm- 3.300mm-4.300mm 4.800mm-5.300mm- 6.300mm-7.300mm-8.000mm-8.300mm	XXX

SUPPLY VOLTAGE	
up to +30VDC (only for A0 output)	L
+10..36 Vdc (for A1-A2-A3-C1 output)	H

OUTPUT TYPE	
Potentiometric - voltage divider- output	A0
0.5...4.5Vdc (powered at +10..36Vdc)	A1
0...10Vdc (powered at +11..36Vdc)	A2
4...20mA output (powered at +10..36Vdc)	A3
CANopen output (powered at +10..36Vdc)	C1

CERTIFICATES	
0	No certificate enclosed
L	Linearity curve enclosed

ACCESSORIES	
X	No accessory enclosed
A	FLA033: fixing flange, A version
B	FLA034: fixing flange, B version
C	CON293: 4-pin female mating connector M12x1; IP67 protection degree
D	CON469: 8-pin female mating connector M12x1; IP67 protection degree

Example of description: GSFMS8000HA1 0000X00

GSF	S	M	S	8000	H	A1	0	000	X	00
	wire transducer	M12 connector	Single	8000mm	+10..36Vdc	0.5...4.5V output	No certificate required	Special execution	No accessories	ND

GEFRAN spa reserves the right to make any kind of design or functional modification at any moment without prior notice.

GEFRAN spa
via Sebina, 74
25050 PROVAGLIO D'ISEO (BS) - ITALIA
tel. 0309888.1 - fax. 0309839063
Internet: <http://www.gefran.com>

GEFRAN

DTS_GSF_03-2019_ENG