

SD card real time datalogger

3 channels 4-20 mA CURRENT RECORDER

Model : MMA-386SD



Your purchase of this 3 channels 4-20 mA CURRENT RECORDER marks a step forward for you into the field of precision measurement. Although this DATA RECORDER is a complex and delicate instrument, its durable structure will allow many years of use if proper operating techniques are developed. Please read the following instructions carefully and always keep this manual within easy reach.

OPERATION MANUAL

TABLE OF CONTENTS

1. FEATURES.....	1
2. SPECIFICATIONS.....	2
3. FRONT PANEL DESCRIPTION.....	4
3-1 Display.....	4
3-2 Logger Button (Enter Button).....	4
3-3 ▲ Button (Time Button).....	4
3-4 ▼ Button (Back Light Button).....	4
3-5 SET Button.....	4
3-6 Hanging holes.....	4
3-7 Stand.....	4
3-8 Battery cover/Battery compartment.....	4
3-9 Screw of the battery cover.....	4
3-10 4-20 mA input socket (CH 1).....	4
3-11 4-20 mA input socket (CH 2).....	4
3-12 4-20 mA input socket (CH 3).....	4
3-13 DC 9V power adapter input socket.....	4
3-14 Reset Button.....	4
3-15 RS-232 Output Terminal.....	4
3-16 SD card socket.....	4
3-17 Hanging unit (with sticker).....	4
3-18 4-20 mA input plug (CH 1).....	4
3-19 4-20 mA input plug (CH 2).....	4
3-20 4-20 mA input plug (CH 3).....	4
4. MEASURING PROCEDURE.....	6
5. DATALOGGER.....	7
5-1 Preparation before execute datalogger function.....	7
5-2 Datalogger.....	9
5-3 Check time information.....	10
5-4 SD Card Data structure.....	10
6. Saving data from the SD card to the computer.....	11
7. ADVANCED SETTING.....	12
7-1 SD memory card Format.....	13
7-2 Set clock time	13
7-3 Set sampling time.....	14
7-4 Set beeper sound ON/OFF.....	14
7-5 Set SD card Decimal character.....	15
7-6 Set RS232 data output ON/OFF.....	16
8. POWER SUPPLY from DC ADAPTER.....	16
9. BATTERY REPLACEMENT.....	16
10. SYSTEM RESET.....	17
11. RS232 PC serial interface.....	17
12. PATENT.....	19

1. FEATURES

- * 4-20 mA current loop recorder with real time data logger, save the measuring data along the time information (year, month, date, hour, minute, second) into the SD memory card and can be downloaded to the Excel, extra software is no need.
- * Input signal : 4 to 20 mA, 3 channels.
- * Resolution : 0.01 mA.
- * Input channels : 3 channels.
- * Show 3 channels (CH1, CH2, CH3) 4-20 mA current loop values in the same LCD.
- * Records time and date along with 4-20 mA DC current measurement value from external sensors, transducers and many other sources.
- * Applications :
 - 4 to 20 mA recording
 - pH recording
 - Low level signal monitoring
 - Photovoltaic studies
 - Battery studies
 - Biological sensor monitoring
 - Factory process control
 - Research and development
 - Medical and Pharmaceutical
 - Environmental studies
- * Large LCD display, easy readout.
- * Low power consumption and long battery life when using battery power.
- * DC 1.5V (UM-4/AAA) battery x 6 PCs or optional DC 9V adapter in.
- * RS232/USB computer interface.

2. SPECIFICATIONS

Circuit	Custom one-chip of microprocessor LSI circuit.
Display	LCD size : 60 mm x 50 mm
Memory Card	SD memory card. 1 GB to 16 GB.
Measurement Signal CH1, CH2, CH3	0 to 20 mA
Accuracy	$\pm (0.5\% + 0.02 \text{ mA})$
Resolution	0.01 mA.
Datalogger Sampling Time	5/10/30/60/120/300/600 seconds
Data error no.	$\leq 0.1 \%$ no. of total saved data typically.
Advanced setting	<ul style="list-style-type: none"> * SD memory card Format * Set clock time (Year/Month/Date, Hour/Minute/Second) * Set sampling time * Set beeper sound ON/OFF * Set SD card Decimal character * Set RS232 data output ON/OFF
Update Time of Display	Approx. 1 second if measuring data is changed.
Data Output	RS 232/USB PC computer interface. <ul style="list-style-type: none"> * <i>Connect the optional RS232 cable UPCB-02 will get the RS232 plug.</i> * <i>Connect the optional USB cable USB-01 will get the USB plug.</i>
Operating Temperature	0 to 50 °C .
Operating Humidity	Less than 85% R.H.

Power Supply	Alkaline or heavy duty DC 1.5 V battery (UM4, AAA) x 6 PCs, or equivalent. or DC 9V adapter input. (AC/DC power adapter is the optional accessory). * <i>Batteries are also the clock backup power source, so if use AC to DC adapter power supply, it is recommend to install the batteries at any time.</i>
Weight	199 g/0.44 LB.
Dimension	132 x 80 x 32 mm (5.2 x 3.1 x 1.3 inch)
Accessories Included	* Instruction manual..... 1 PC * Hanging unit (with sticker)..... 1 PC * Wire plug for input socket..... 3 PCs
Optional Accessories	* AC to DC 9V adapter. * SD Card (4 GB). * USB cable, USB-01. * RS232 cable, UPCB-02. * Data Acquisition software, SW-U801-WIN. * Excel Data Acquisition software, SW-E802.

3. FRONT PANEL DESCRIPTION

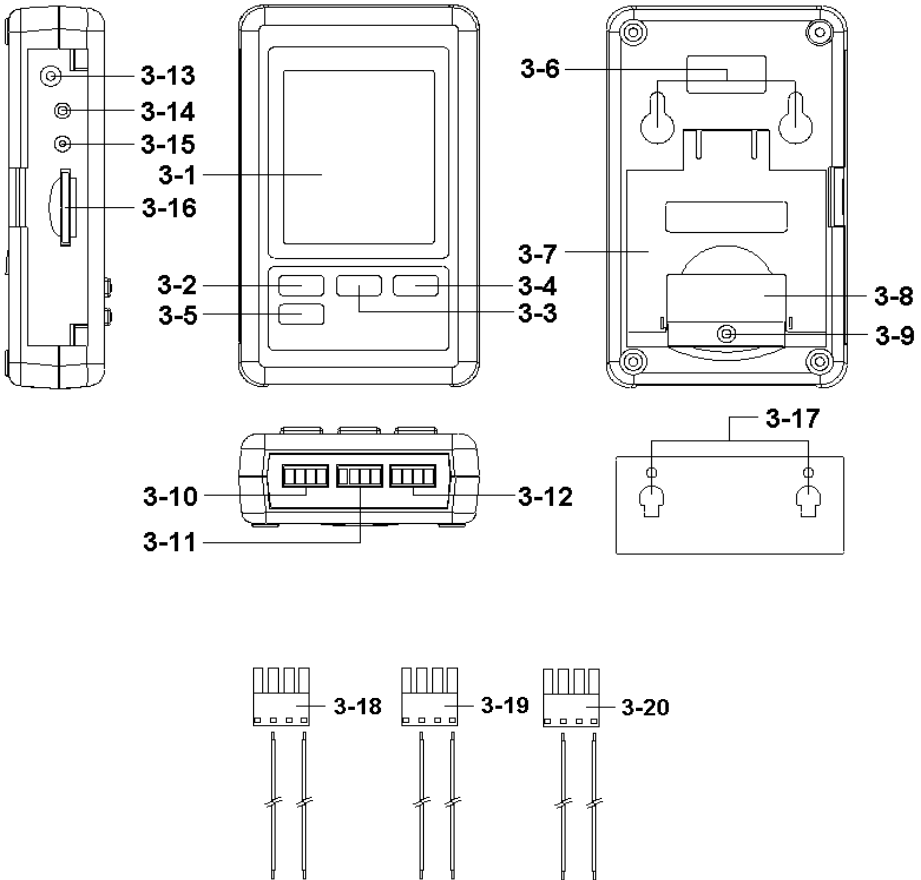

Fig. 1

- 3-1 Display
- 3-2 Logger button (Enter button)
- 3-3 ▲ Button (Time Button)
- 3-4 ▼ Button (Back Light Button)
- 3-5 SET Button
- 3-6 Hanging holes
- 3-7 Stand
- 3-8 Battery cover/Battery compartment
- 3-9 Screw of the battery cover
- 3-10 4-20 mA input socket (CH 1)
- 3-11 4-20 mA input socket (CH 2)
- 3-12 4-20 mA input socket (CH 3)
- 3-13 DC 9V power adapter input socket
- 3-14 Reset Button
- 3-15 RS-232 Output Terminal
- 3-16 SD card socket
- 3-17 Hanging unit (with sticker)
- 3-18 4-20 mA input plug (CH 1)
- 3-19 4-20 mA input plug (CH 2)
- 3-20 4-20 mA input plug (CH 3)

4. MEASURING PROCEDURE

1) Power supply installation :

- * The meter's power supply should install the batteries and connect " AC to DC adapter " together.
- * The batteries are the backup power of " Clock ", if meter install the batteries only and not connect the " AC to DC adapter ", meter only can measure the input mA value and the function of SD card data logger is disable, it also can not show other function.

Batteries

Install the batteries into the battery compartment :

- * Loose the " Screw of the battery cover " (3-9, Fig. 1) and take away the " Battery Cover " (3-8, Fig. 1) from the meter.
- * Replace with DC 1.5 V battery (UM4/AAA, Alkaline/Heavy duty type) x 6 PCs, and reinstate the cover.
- * Make sure the battery cover is secured after changing the battery.

AC to DC adapter

- * The " AC to DC adapter " is the standard accessory.
- * Plug the output plug of " AC to DC adapter " into the " DC 9V power adapter input socket " (3-13, Fig. 1)

2) Connect the measured 4-20 mA signal wires to

4-20 mA CH 1 input plug (3-18, Fig. 1)

4-20 mA CH 2 input plug (3-19, Fig. 1)

4-20 mA CH 3 input plug (3-20, Fig. 1)

please make the attention of the wire's polarity (+, -).

- 3) Plug in the above plugs into
- 4-20 mA CH 1 input socket (3-10, Fig. 1)
 - 4-20 mA CH 1 input socket (3-11, Fig. 1)
 - 4-20 mA CH 1 input socket (3-12, Fig. 1)

Remark :

- * The up Display value will present the CH1 pressure value.*
- * The middle Display value will present the CH2 pressure value.*
- * The low Display value will present the CH3 pressure value.*

5. DATALOGGER

5-1 Preparation before execute datalogger function

a. Insert the SD card

Prepare a " SD memory card " (1 GB to 16 GB, optional), insert the SD card into the " SD card socket " (3-16, Fig. 1) with the correct direction exactly.

**** It recommend use memory card's capacity is \leq 4 GB.***

b. SD card Format

If SD card just the first time use into the meter, it recommend to make the " SD card Format " at first, please refer chapter 7-1 (page 13).

**** It recommend strongly, do not use memory cards that have been formatted by other meter or by other installation (such as camera...). Reformat the memory card with your meter.***

**** If the SD memory card exist the trouble during format by the meter, use the Computer to reformat again can fix the problem.***

c. Time setting

If the meter is used at first time, it should to adjust the clock time exactly, please refer chapter 7-2 (page 13).

d. Decimal format setting



The numerical data structure of SD card is default used the " ." as the decimal, for example "20.6" "1000.53" . But in certain countries (Europe ...) is used the " ," as the decimal point, for example " 20, 6 " , "1000,53". Under such situation, it should change the Decimal character at first, details of setting the Decimal point, refer to Chapter 7-5, page 15

e. Information of LCD display

* If the Display show :

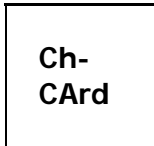

It means that the SD card exist the problem or the SD card memory is full, it should change SD memory card.

* If the Display show :

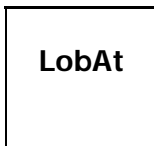

It means that the battery is low voltage.

* If the Display show :

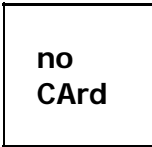

It means that the SD card is not plugged into the meter.

5-2 Datalogger

a. Start the datalogger

Press the " Logger button (3-2, Fig. 1) > 2 seconds continuously, until the Display show the indicator " DATALOGGER ", release the " Logger Button " (3-2, Fig. 1), then the measuring data along the time information will be saved into the memory circuit.

Remark :

** How to set the sampling time, refer to Chapter 7-3, page 14.*

** How to set the beeper sound is enable, refer to Chapter 7-4, page 14.*

b. Finish the Datalogger

During execute the Datalogger function (Display show the " Datalogger " indicator), press the " Logger button " (3-2, Fig. 1) > 2 seconds continuously, until the Display indicator " DATALOGGER " is disappeared, release the " Logger Button " will finish the Datalogger function.



Before take away the SD card from the meter, it should execute the procedures of " Finish the Datalogger ",
(It should wait for the Display counter to count down to zero value.)

otherwise some existing recent save data may loss.

5-3 Check time information

Press " Time button " (3-3, Fig. 1) > 2 seconds continuously, the LCD display will present the time information of Year/Month/Date, Hour/Minute/Second and the sampling value.

5-4 SD Card Data structure

1) When the first time, the SD card is used into the meter, the SD card will generate a folder :

MAA01

2) If the first time to execute the Datalogger, under the route MAA01\, will generate a new file name MAA01001.XLS.

After exist the Datalogger, then execute again, the data will save to the MAA01001.XLS until Data column reach to 30,000 columns, then will generate a new file, for example MAA01002.XLS

3) Under the folder MAA01\, if the total files more than 99 files, will generate anew route, such as MAA02\

4) The file's route structure :

```
MAA01\  
  MAA01001.XLS  
  MAA01002.XLS  
  .....  
  MAA01099.XLS  
MAA02\  
  MAA02001.XLS  
  MAA02002.XLS  
  .....  
  MAA02099.XLS  
MAA0X\  
  .....
```

Remark :

XX : Max. value is 10.

6. Saving data from the SD card to the computer (EXCEL software)

- 1) After execute the Data Logger function, take away the SD card out from the " SD card socket " (3-16, Fig. 1).
- 2) Plug in the SD card into the Computer's SD card slot (if your computer build in this installation) or insert the SD card into the " SD card adapter ". then connect the " SD card adapter " into the computer.
- 3) Power ON the computer and run the " EXCEL software ". Down load the saving data file (for example the file name : MAA01001.XLS, MAA01002.XLS) from the SD card to the computer. The saving data will present into the EXCEL software screen (for example as following EXCEL data screens) , then user can use those EXCEL data to make the further Data or Graphic analysis usefully.

EXCEL data screen (for example)

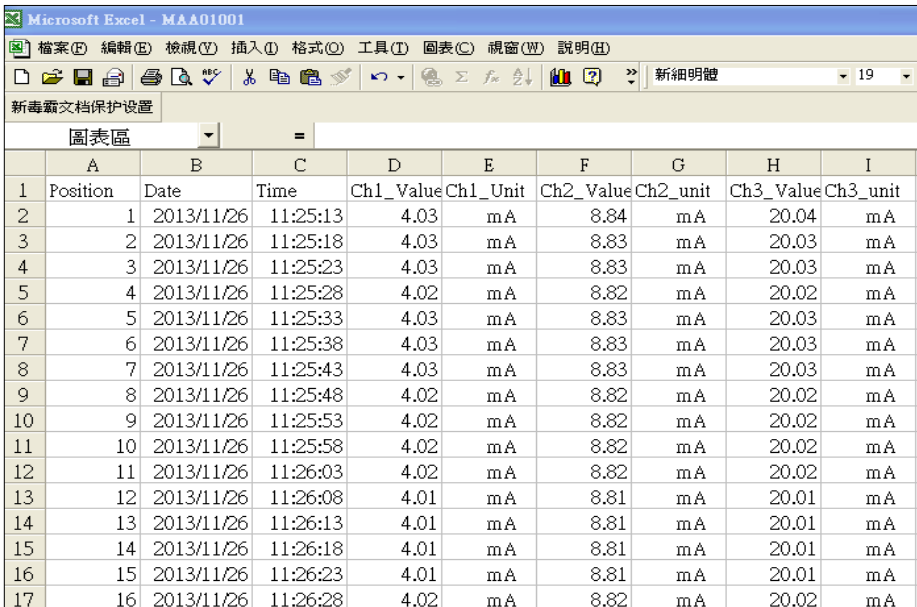

	A	B	C	D	E	F	G	H	I
1	Position	Date	Time	Ch1_Value	Ch1_Unit	Ch2_Value	Ch2_unit	Ch3_Value	Ch3_unit
2	1	2013/11/26	11:25:13	4.03	mA	8.84	mA	20.04	mA
3	2	2013/11/26	11:25:18	4.03	mA	8.83	mA	20.03	mA
4	3	2013/11/26	11:25:23	4.03	mA	8.83	mA	20.03	mA
5	4	2013/11/26	11:25:28	4.02	mA	8.82	mA	20.02	mA
6	5	2013/11/26	11:25:33	4.03	mA	8.83	mA	20.03	mA
7	6	2013/11/26	11:25:38	4.03	mA	8.83	mA	20.03	mA
8	7	2013/11/26	11:25:43	4.03	mA	8.83	mA	20.03	mA
9	8	2013/11/26	11:25:48	4.02	mA	8.82	mA	20.02	mA
10	9	2013/11/26	11:25:53	4.02	mA	8.82	mA	20.02	mA
11	10	2013/11/26	11:25:58	4.02	mA	8.82	mA	20.02	mA
12	11	2013/11/26	11:26:03	4.02	mA	8.82	mA	20.02	mA
13	12	2013/11/26	11:26:08	4.01	mA	8.81	mA	20.01	mA
14	13	2013/11/26	11:26:13	4.01	mA	8.81	mA	20.01	mA
15	14	2013/11/26	11:26:18	4.01	mA	8.81	mA	20.01	mA
16	15	2013/11/26	11:26:23	4.01	mA	8.81	mA	20.01	mA
17	16	2013/11/26	11:26:28	4.02	mA	8.82	mA	20.02	mA

EXCEL graphic screen (for example)

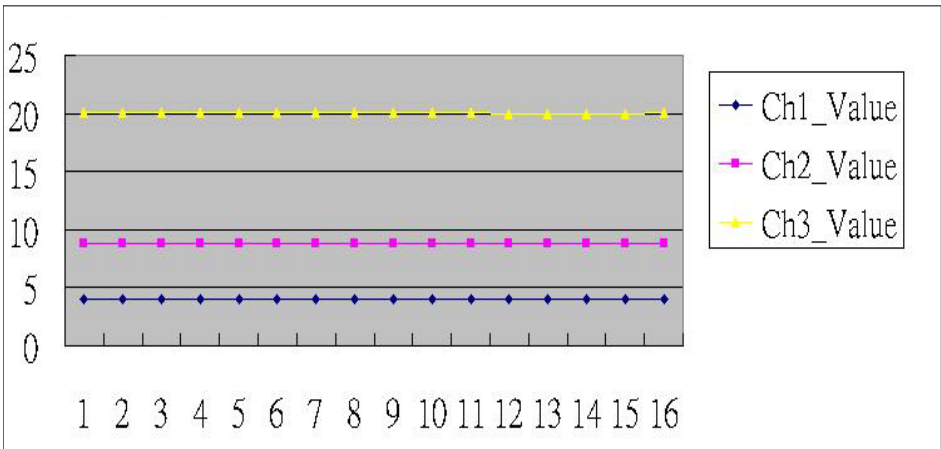

7. ADVANCED SETTING

Under do not execute the Datalogger function, press the " SET button " (3-5, Fig. 1) > 2 seconds continuously will enter the " Setting " mode., then release the " SET button ". Following press the " SET button " (3-5, Fig. 1) once a while in sequence to select the seven main function, the display will show :

- Sd F**..... SD memory card Format
- dAtE**.....Set clock time (Year/Month/Date, Hour/Minute/Second)
- SP-t**..... Set sampling time
- bEEP**.....Set beeper sound ON/OFF
- dEC**.....Set SD card Decimal character
- rS232**... Set RS232 data output ON/OFF

Remark :

During execute the " Setting " function, if within 5 seconds , do not press any buttons further, the LCD Display will return to normal screen.

7-1 SD memory card Format

When the Display show " Sd F "

- 1) Use the " ▲ Button " (3-3, Fig. 1) or " ▼ Button " (3-4, Fig. 1) to select the upper value to " yES " or " no " .

yES - Intend to format the SD memory card
no - Not execute the SD memory card format

- 2) If select the upper to " yES ", press the " Enter Button " (3-2, Fig. 1) once again, the Display will show text " yES Enter " to confirm again, if make sure to do the SD memory card format, then press " Enter Button " once will format the SD memory clear all the existing data that already saving into the SD card.

7-2 Set clock time (Year/Month/Date, Hour/Minute/ Second)

When the Display show " dAtE "

- 1) Use the " ▲ Button " (3-3, Fig. 1) or " ▼ Button " (3-4, Fig. 1) to adjust the value (Setting start from Year value). After the desired value is set, press the " Enter button " (3-2, Fig. 1) once will going to next value adjustment (for example, first setting value is Year then next to adjust Month, Date, Hour, Minute, Second value).

Remark :

The adjusted unit will be flashed.

- 2) After set all the time value (Year, Month, Date, Hour, Minute, Second), press the " SET button " (3-5, Fig. 1) once will save the time value, then the screen will jump to " Sampling time " setting screen (Chapter 7-3).

Remark :

After the time value is setting, the internal clock will run precisely even Power off if the battery is under normal condition (No low battery power).

7-3 Set sampling time

When the Display show " SP-t "

- 1) Use the " ▲ Button " (3-3, Fig. 1) or " ▼ Button " (3-4, Fig. 1) to adjust the sampling value :

***5 seconds, 10 seconds, 30 seconds, 60 seconds,
120 seconds, 300 seconds, 600 seconds, Auto.***

After the desired value is set, press the " Enter Button " (3-2, Fig. 1) to save the adjusting value with default.

Remark :

The " Auto " sampling time means when the measuring value is changed ($> \pm 10$ digits) will save the data to the memory circuit one time.

7-4 Set beeper sound ON/OFF

When the Display show " bEEP "

- 1) Use the " ▲ Button " (3-3, Fig. 1) or " ▼ Button " (3-4, Fig. 1) to select the data to " yES " or " no ".

yES - Meter's beep sound will be ON with default.
no - Meter's beep sound will be OFF with default.

- 2) After select the upper text to " yES " or " no ", press the " Enter Button " (3-2, Fig. 1) will save the setting function with default.

7-5 Decimal point of SD card setting

When the Display show " dEC "

The numerical data structure of SD card is used the " . " as the decimal with default, for example "20.6" "1000.53" . But in certain countries (Europe ...) is used the " , " as the decimal point, for example " 20,6 " "1000,53". Under such situation, it should change the Decimal character at first.

- 1) Use the " ▲ Button " (3-3, Fig. 1) or " ▼ Button " (3-4, Fig. 1) to select the upper text to " USA " or " Euro " .

USA - Use " . " as the Decimal point with default.
Euro - Use " , " as the Decimal point with default.

- 2) After select the text to " USA " or " Euro ", press the " Enter Button " (3-2, Fig. 1) will save the setting function with default.

7-6 Set RS232 data output ON/OFF

When the Display show " rS232 "

- 1) Use the " ▲ Button " (3-3, Fig. 1) or " ▼ Button " (3-4, Fig. 1) to select the upper Display text to "yES " or " no ".

**yES - RS-232 output terminal (3-15, Fig. 1)
will send the RS232 signal output.**

**no - RS-232 output terminal (3-15, Fig. 1)
will not send the RS232 signal output.**

- 2) After Display text is selected to " yES " or " no ", press the " Enter Button " (3-2, Fig. 1) will save the setting function with default.

8. POWER SUPPLY from DC ADAPTER

The meter also can supply the power supply from the DC 9V Power Adapter. Insert the plug of Power Adapter into " DC 9V Power Adapter Input Socket " (3-13, Fig. 1).

9. BATTERY REPLACEMENT

- 1) When the left corner of LCD display show "  ", it is necessary to replace the battery. However, in-spec. measurement may still be made for several hours after low battery indicator appears before the instrument become inaccurate.
- 2) Loose the " Screw of the battery cover " (3-9, Fig. 1) and take away the " Battery Cover " (3-8, Fig. 1) from the instrument and remove the battery.

- 3) Replace with DC 1.5 V battery (UM4/AAA, Alkaline/heavy duty) x 6 PCs, and reinstate the cover.
- 4) Make sure the battery cover is secured after changing the battery.

10. SYSTEM RESET

If the meter happen the troubles such as :

CPU system is hold (for example, the key button can not be operated...).

Then make the system RESET will fix the problem.
The system RESET procedures will be either following method :

During the power on, use a pin to press the " Reset Button " (3-14, Fig. 1) once a while will reset the circuit system.

11. RS232 PC SERIAL INTERFACE

The instrument has RS232 PC serial interface via a 3.5 mm terminal (3-15, Fig. 1) if the RS232 function already select to " ON ", refer to chapter 7-6, page 16.

The data output is a 16 digit stream which can be utilized for user's specific application.

A RS232 lead with the following connection will be required to link the instrument with the PC serial port.

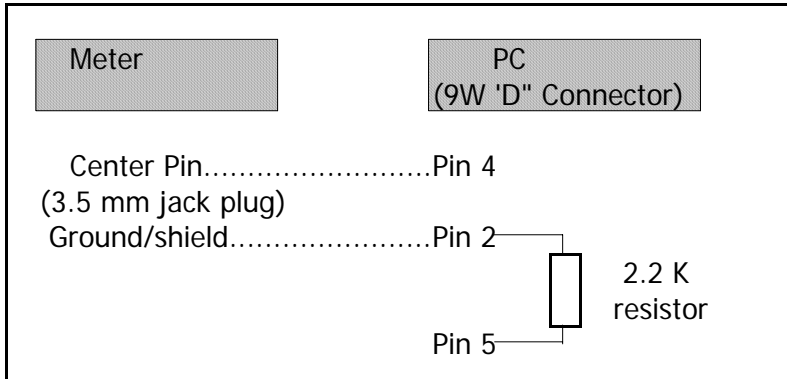

The 16 digits data stream will be displayed in the following format :

D15 D14 D13 D12 D11 D10 D9 D8 D7 D6 D5 D4 D3 D2 D1 D0

Each digit indicates the following status :

D0	End Word
D1 & D8	Display reading, D1 = LSD, D8 = MSD For example : If the display reading is 1234, then D8 to D1 is : 00001234
D9	Decimal Point(DP), position from right to the left 0 = No DP, 1 = 1 DP, 2 = 2 DP, 3 = 3 DP
D10	Polarity 0 = Positive 1 = Negative
D11, D12	Annunciator for Display mA = 37

D13	When send the up display data = 1 When send the middle display data = 2 When send the low display data = 3
D14	4
D15	Start Word

RS232 FORMAT : 9600, N, 8, 1

Baud rate	9600
Parity	No parity
Data bit no.	8 Data bits
Stop bit	1 Stop bit

12. PATENT

The meter (SD card structure) already get patent or patent pending in following countries :

Germany	Nr. 20 2008 016 337.4
JAPAN	3151214
CHINA	ZL 2008 2 0189918.5 ZL 2008 2 0189917.0